



# Technical Guidelines on Retro-commissioning



2017

(back blank page of front cover)



<u>Table of Contents</u>	<u>Page No.</u>
<b>1. Introduction</b>	<b>1</b>
1.1 Background	1
1.2 Benefits of Retro-commissioning	1
1.3 Overview and Objectives of Retro-commissioning	1
1.4 Overview and Objectives of Energy Audit	2
1.5 Difference between Retro-commissioning and Energy Audit	2
1.6 Aim of the Technical Guidelines	2
<b>2. Interpretations</b>	<b>3</b>
<b>3. How to Conduct Retro-commissioning for a Building</b>	<b>5</b>
3.1 Overview	5
3.1.1 Roles and Responsibilities of RCx Team	6
3.1.2 Selection of Suitable RCx Service Provider	7
3.1.3 Time and Budget Considerations in RCx	7
3.2 Stage 1 – Planning	8
3.2.1 Collect Building Documentation	9
3.2.2 Collect Current Facilities Requirements	9
3.2.3 Carry out Initial Building Walk-Through and interview with O&M staff	9
3.2.4 Conduct Initial Analysis based on Existing Central Control and Monitoring System (CCMS) / Log sheet data	10
3.2.5 Consider Performing Energy Modelling (Optional)	10
3.2.6 Develop a RCx Plan	11
3.3 Stage 2 – Investigation	12
3.3.1 Collection of Trend Logged Data	13
3.3.2 Analyze Trend Logged Data	13
3.3.3 Identify Potential Energy Saving Opportunities (ESOs) Setting of Measurement and Verification Methods of Energy	14
3.3.4 Saving Opportunities (ESOs)	14
3.3.5 Selection of Energy Saving Opportunities (ESOs) for Implementation	14
3.4 Stage 3 – Implementation	15
3.4.1 Implement Selected Energy Saving Opportunities (ESOs)	16
3.4.2 Performing Measurement and Verification	16
3.4.3 Develop a RCx Final Report	18



3.4.4	Develop an Ongoing Commissioning Plan	18
3.4.5	Conduct Training for O&M Staff	18
3.5	Stage 4 – Ongoing Commissioning	20
3.6	Application of Energy Modelling in RCx (Optional Method)	21
3.6.1	Benefits and Considerations	22

#### 4. Appendices

<b>Appendix A</b>	Sample Technical Approach for Identification of Energy Saving Opportunities (ESOs)
-------------------	--

#### 5. Supplementary Information Forms for Stage 1 to Stage 4

##### Stage 1 Forms

Form 1.1	Building Design and Operational Information Checklist
Form 1.2	Current Facilities Requirements Form
Form 1.3	Building Walk-Through Checklist
Form 1.4	RCx Plan

##### Stage 2 Forms

Form 2.1	Instrumentation for Data Collection using Portable Data Logger
Form 2.2	Data Collection Form
Form 2.2a	Chilled Water Plant – Chiller Data Collection Form
Form 2.2b	Chilled Water Plant – Chilled Water Pump Data Collection Form
Form 2.2c	Heat Rejection Plant – Cooling Tower Data Collection Form
Form 2.2d	Heat Rejection Plant – Condensing Water Pump Data Collection Form
Form 2.2e	Central Hot Water Plant Data Collection Form
Form 2.2f	Central Hot Water Plant – Hot Water Pump Data Collection Form
Form 2.2g	Air Side System – AHU / PAU / FCU Data Collection Form
Form 2.3	List of Proposed Energy Saving Opportunities (ESOs)
Form 2.4	List of Proposed Repairing Items
Form 2.5	Investigation Report

##### Stage 3 Forms

Form 3.1	Implementation Report
----------	-----------------------

##### Stage 4 Forms

Form 4.1	On-going Commissioning Report
----------	-------------------------------



## Acknowledgement

We would like to express our utmost thanks to Hong Kong Green Building Council (HKGBC) who have shared their valuable experience on RCx and contributed to the formulation of this Technical Guidelines.

## 1. Introduction

### 1.1 Background

In the Energy Saving Plan for Hong Kong's Built Environment 2015~2025+ published by Environment Bureau in collaboration with Development Bureau and Transport and Housing Bureau in May 2015, it is stated that "Retro-commissioning" is one of the key initiatives to promote energy saving for existing building.

Retro-commissioning (RCx) is a systematic process to periodically check an existing building's performance to identify operational improvements that can save energy and thus lower energy bills and improve indoor environment.

### 1.2 Benefits of Retro-commissioning

There are many benefits brought by RCx and some are shown as the following:-

- provide the building energy cost savings with no or low investment with short payback period;
- reduce the operation and maintenance (O&M) cost;
- reduce the chance of energy consuming equipment/ systems failure and extend the equipment life;
- ensure the energy consuming equipment/ systems operate at the most efficient level; provide a healthy and comfortable indoor environment for the occupants;
- increase the asset value of the building and
- build up the knowledge and skills within the building management team for development of O&M industry.

### 1.3 Overview and Objectives of Retro-commissioning

"Retro-commissioning" covers the scope of "existing building commissioning", "re-commissioning" and "continuous commissioning". There are four stages in RCx: Stage 1- Planning, Stage 2- Investigation, Stage 3- Implementation and Stage 4- Ongoing commissioning. The RCx commences from collection of operational data of energy consuming equipment/systems, followed with site measurement testing and data analysis and then come up with proposed Energy Saving Opportunities (ESOs). Through the implementation of the ESOs, the operational performance of building systems improve which in turn enhances the building energy efficiency.





## 1.4 Overview and Objectives of Energy Audit

An energy audit involves the systematic review of the energy consuming equipment/ systems in a building to identify energy management opportunities (EMO), which provides useful information for the building owner to decide on and implement the energy saving measures for environmental consideration and economic benefits.

An energy audit commences with the collection and analysis of relevant information that may affect the energy consumption of the building, followed with the reviewing of the collected information, the analyzing of the conditions and performance of existing equipment, systems and installations, and the energy bills. Energy audit can achieve energy efficiency and conservation through the implementation of EMO identified in the audit.

## 1.5 Difference between Retro-commissioning and Energy Audit

RCx is more focused on checking whether the energy consuming equipment / systems operate properly as design or users' requirements and to identify some area of improvements (e.g. shifting of system control settings, inaccuracy of sensors, improper operational schedules and improper air & water balancing, etc.). Besides, RCx has an implementation of ESOs and ongoing commissioning plan for the building owners to implement and maintain the building operating in high energy efficiency level.

## 1.6 Aim of the Technical Guidelines

In Hong Kong, there is not yet a single guideline for the building owners on RCx. This Technical Guidelines on Retro-commissioning (TG-RCx) is designed to serve as a basic and clear procedural guidance on RCx.

As to facilitate building owners to carry out RCx, various checklists, data collection forms and report templates are developed. Some examples of ESOs that commonly found in RCx have also mentioned in this TG-RCx for reference.

As to maintain the benefits of RCx, this TG-RCx also addresses the importance of the ongoing commissioning and proposes the persistence strategies for the building owner's reference.

## 2. Interpretations

**'air-conditioning'** means the process of cooling, heating, dehumidification, humidification, air distribution or air purification.

**'air handling unit (AHU)'** means an equipment that includes a fan or blower, cooling and/or heating coils, and provisions for air filtering and condensate drain etc.

**'chilled/heated water plant'** means a system of chillers/heat pumps, with associated chilled/heated water pumps and if applicable associated condenser water pumps, cooling towers and/or radiators.

**'chiller'** means an air conditioning equipment that includes evaporator, compressor, condenser, and regulator controls, which serves to supply chilled water.

**'coefficient of performance (COP) - cooling'** means the ratio of the rate of heat removal to the rate of energy input, in consistent units, for an air-conditioning equipment.

**'coefficient of performance (COP), heat pump - heating'** means the ratio of the rate of heat delivered to the rate of energy input, in consistent units, for a heat pump type air conditioning equipment.

**'constant air volume (CAV) air distribution system'** means a system that controls the dry-bulb temperature within a space by varying the temperature of supply air that is maintained at constant volume flow to the space.

**'electrical installation'** means fixed equipment, distribution network or accessories for electricity distribution or utilization in the building.

**'energy saving opportunity (ESO)'** is the saving opportunity that can be found after the investigation stage of RCx.

**'equipment'** means any item for such purposes as conversion, distribution, measurement or utilization of electrical energy, such as luminaires, air conditioning equipment, motors, motor drives, machines, transformers, apparatus, meters, protective devices, wiring materials, accessories and appliances.

**'escalator'** should have the same meaning assigned by section 2 of the Lifts and Escalators Ordinance (Cap. 618).

**'harmonics'** means a component frequency of the periodic oscillations of an electromagnetic wave that is an integral multiple of the fundamental frequency, being 50 Hz for the power distribution system in Hong Kong.

**'implementation stage'** means a stage that carries out the selected energy saving opportunities (ESOs). A verification process will also be carried out so as to see if the ESO contributes to any energy savings. After the whole implementation and verification, a final RCx report should be carried out which summarizes the progress of above stages.

**'investigation stage'** means a stage that includes an in-depth system analysis so as to find out the possible energy gaps. A detailed list of recommended energy saving opportunities (ESOs) should be provided showing estimated energy savings and payback period. The methodology of energy saving verification should be presented clearly. A list of selected energy saving opportunities (ESOs) should be confirmed at the end of this stage and agreed by the building owner(s)/ facility manager.

**'lift'** should have the same meaning assigned by section 2 of the Lifts and Escalators Ordinance (Cap. 618).



**'lighting installation'** means a fixed electrical lighting system in the building

**'luminaire'** means a lighting device, which distributes light from a single lamp or a group of lamps; a luminaire should include control gears if applicable, and all necessary components for fixing and mechanical protection of lamps.

**'meter'** means a measuring instrument to measure, register or indicate the value of voltage, current, power factor, electrical consumption or demand, water flow, energy input/output etc.

**'on-going commissioning stage'** means a stage that aims at ensuring building systems remain optimized continuously. Thus, data will be continuously gathered and compared.

**'planning stage'** means a stage that includes the collection of building documentation such as schematic drawings, layout plans, electricity bills, etc. For the understanding of building system operations, an initial site walk-through should be carried out. After having a walk-through and reading the trend log data, a RCx plan should be written which covers system analysis and upcoming site measurement plan.

**'retro-commissioning'** means a knowledge based systematic process to periodically check an existing building's performance to identify operational improvements than can save energy and thus lower energy bills and improve indoor environment.

**'variable air volume (VAV) air distribution system'** means a system that controls the dry-bulb temperature within a space by varying the volume of supply air to the space automatically as a function of the air-conditioning load.

**'variable speed drive (VSD)'** of a motor means a motor drive that controls the motor speed over a continuous range.

### 3. How to Conduct Retro-commissioning for a Building

#### 3.1 Overview

There are four (4) stages in RCx. In each stage, the major activities are shown as the following:

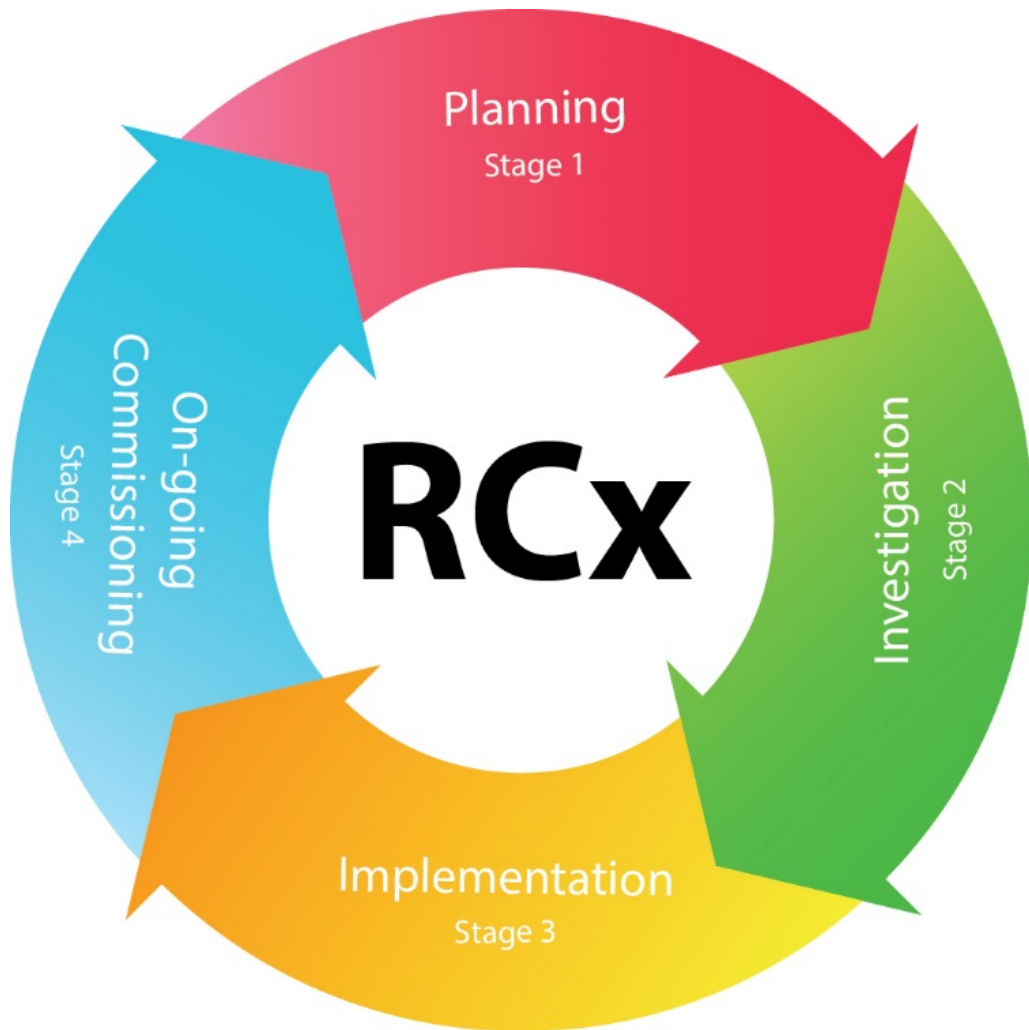

Fig. 3.1 RCx Procedures

From planning stage to investigation stage, the goal is to search as much as possible for the Energy Saving Opportunities (ESOs) and the operational problems underneath, which will lead to inefficient energy use or unsatisfactory indoor environment.

Upon the identification of proposed ESOs and the underlying operational problems, RCx Team should prepare an investigation report including the cost and benefits analysis on the proposed ESOs, implementation details, measurement and verification methods and the anticipated disturbance to normal services operation and discuss within the relevant stakeholders. The proposed ESOs should be agreed with the building owner before implementation.

During the implementation stage, regular RCx meeting should be held to monitor the implementation progress.

In ongoing commissioning stage, an ongoing commissioning plan should be developed by the RCx Team to maintain the benefits from RCx. Training to the O&M staff is also essential to implement the ongoing commissioning plan on RCx.

### 3.1.1 Roles and Responsibilities of RCx Team

If Building Owners think that their in-house O&M staff are capable of carrying out RCx, they can choose to carry out the RCx by their O&M staff. Usually, in-house O&M staff are most suitable parties to conduct RCx for the building since they are familiar with equipment/services/systems & operational pattern of the building. If not, the Building Owner may consider to engage a RCx service provider to carry out the RCx.

Before the commencement of RCx, a RCx Team should be formed and the essential parties involved in RCx Team are as the following–

- (1) Building Owner (or Building Owner's representative)
- (2) Building Manager
- (3) O&M staff;
- (3) Contractor and
- (4) RCx service provider (optional);

If building owner engage a RCx service provider to conduct RCx, RCx service provider, as the members of RCx team, will assist to carry out the RCx and report to the building owner for the findings such as energy saving opportunities (ESOs). Then, RCx Team should seek building owner's agreement on the proposed energy saving opportunities

(ESOs) before carrying out those selected ESOs in implementation phase. RCx Team can engage contractor for carrying out the ESO implementation works.



Remarks: Building Owner can delegate Service Provider to study RCx report in any stage to carry on the detailed analysis if problems are encountered.  
 - - - - - represents the suggested stage that Building Owner can delegate Service Provider to step in.  
 ——— represents the involvement of each party in different stage.  
 (\*) Facility Manager and O&M Staff should be key coordinator through out the whole RCx study

### 3.1.2 Selection of Suitable RCx Service Provider

Central Control and Monitoring System (CCMS) is capable to provide the required operational data. However for some existing buildings which have no CCMS, or the CCMS has no sufficient capacity to measure, store or present the required data, the data must be collected by short-term on-site measurement by portable data loggers. In this case, RCx Team should be able to collect relevant data by using appropriate portable data logger for trend data logging. If not, engagement of RCx services provider would be one of the options for conducting RCx.

Furthermore, if resources allowed, the RCx service provider may adopt computerized energy simulation by establishing building energy modelling for deeper energy saving. Through the energy models, we can simulate different scenarios under different proposed ESOs and it can provide useful information to the building owner in selection of ESOs for implementation.

### 3.1.3 Timing and Resources Considerations in RCx

If the building owner would like to have an in-depth and complete analysis of the existing operational conditions of the building systems, the data collection is suggested to be carried out throughout a year so that the operational trends in cooling, heating and intermediate seasons can be examined in full. This can help to identify the most significant potential ESOs, which is the ultimate goal of the RCx.

In case resource is limited, choose the most probable season where the most significant underlying operational problems would occur for diagnostic monitoring.

3.2 Stage 1 – Planning

The below working steps and expected deliverables in planning stage are shown as the following

–

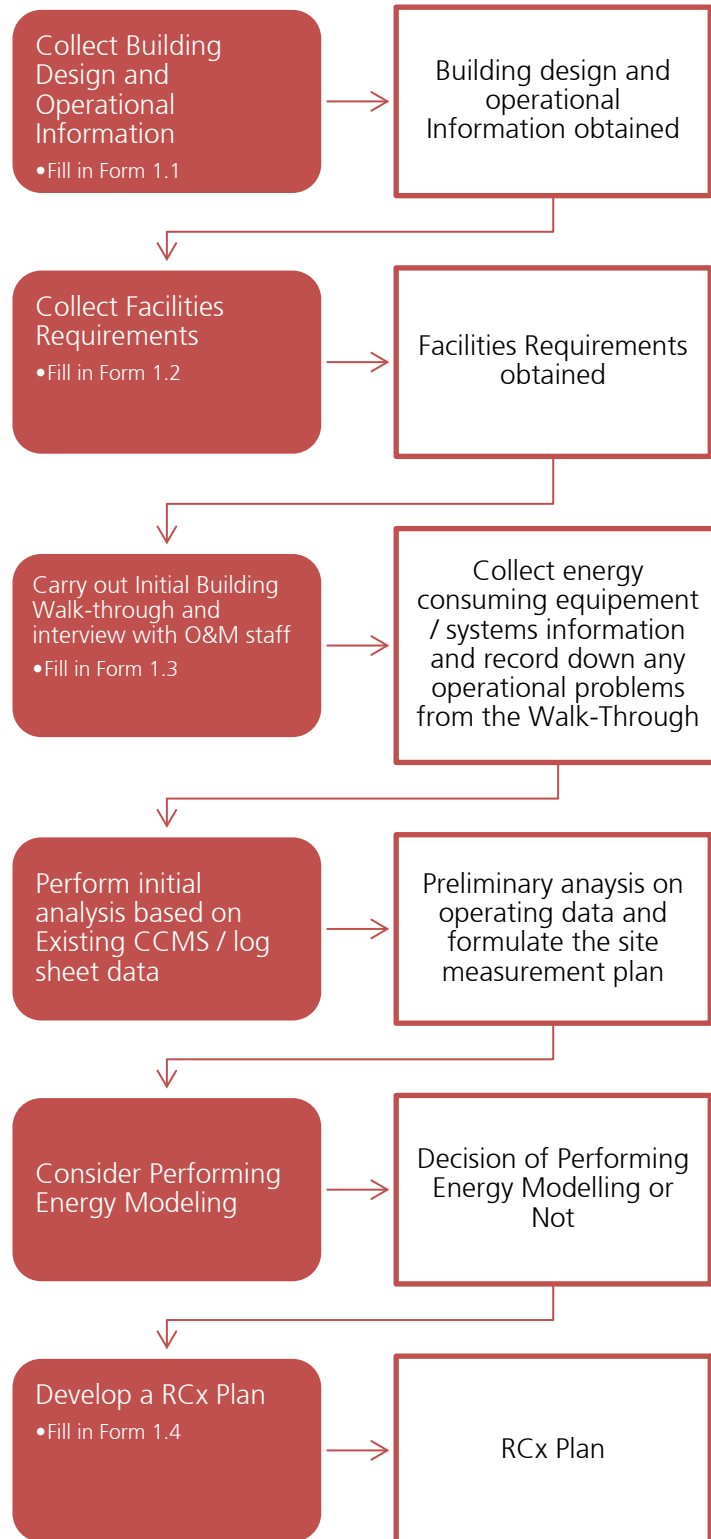

Fig. 3.2 The Flow Chart for Planning Stage



### 3.2.1 Collect Building Documentation

The first step by RCx Team is to obtain as much building design and operational information as possible in order to familiarize the building operation at present. RCx Team needs to collect HVAC, Electrical, Lighting, Plumbing, Lift and Escalator system schematic diagrams and relevant services layout plans in order to familiarize plant operation and for further planning of their site investigation work. Most importantly, RCx Team should collect the CCMS data / log sheet data, if available, for analysis in later stage.

RCx Team should also collect the electricity bills and metering data in past three years for analysis of energy consumption breakdown and profiles. These information is useful to RCx Team to determine which types of installation may have the greater potential for energy saving.

Form 1.1 Building Design and Operational Information Checklist;

### 3.2.2 Collect Current Facilities Requirements

A Current Facilities Requirements Form has been developed to facilitate the users to collect the relevant information from the building manager. In this form, occupant comfort is investigated and it mainly covers air-conditioning and lighting installation.

By reference to these facilities requirements, RCx Team can check whether the existing systems can perform and meet these requirements. If the existing systems cannot meet these requirements, it may have some operational problems and this will be the areas for further site investigation.

Form 1.2 Current Facilities Requirements Form

### 3.2.3 Carry out Initial Building Walk-through and interview with O&M staff

After collecting the information of the energy consuming equipment and systems, RCx Team especially the O&M staff will perform an initial building walk-through to observe the operation condition and to counter check if the given and collected information is





the same as the actual installation. Through the interview with the O&M staff, we may record some areas for improvement and/or operational gaps. Some examples are shown as the following:–

- systems that simultaneously and excessively heat and cool;
- pumps not operating as scheduled;
- equipment operated or lighting switched on unnecessary, especially air handling units that operate for extended periods when the building is unoccupied;
- improper building pressurization of either positive or negative e.g. doors that are difficult to open or close;
- equipment or piping that is unreasonably hot or cold; unusual noises at valves or other mechanical equipment; and
- spaces that are over-illuminated.

Form 1.3 Building Walk-Through Checklist;

### 3.2.4 Conduct Initial Analysis based on Existing Central Control and Monitoring System (CCMS) / Log Sheet Data

RCx Team should conduct initial analysis based on CCMS / log sheet data and check whether the data collected are accurate and reasonable. The following items should be included in the preliminary analysis.

1. Chiller plant
2. Heat rejection system
3. Water side system
4. Air side system
5. Electrical system
6. Lighting system
7. Lift & Escalator
- 8.

By doing this, RCx Team can assess the current operational conditions of existing building systems and formulate onwards site measurement plans.

### 3.2.5 Consider Performing Energy modelling (Optional)

The building owner can consider performing energy modelling for the building, if sufficient building information is available for input to such energy simulation. For certain instance, where data is not always available, simulation should be used to extrapolate beyond a year using historical weather data. Energy modelling can (1) evaluate accurately the detailed breakdown of energy use for the building; and (2) evaluate the amount of energy cost saving to help selecting the identified opportunities.

For details, please refer to Section 3.6 – Application of Energy modelling in RCx (Optional).

### 3.2.6 Develop a RCx Plan

To summarize all the findings in planning stage and plan the subsequent activities in RCx for optimizing the existing building, RCx Team will develop a RCx plan which includes the following items –

#### Summary of the Findings in Planning Stage

- General description of the Building
- Overview of energy consuming equipment/ systems
- Description of facilities requirements
- Preliminary analysis on CCMS data/ log sheet data
- Preliminary analysis (Energy Modeling) - Optional

#### Actions Forward in the Following Stages

- Site Measurement Plan
- Data that needs to be collected
- Data that needs to be verified

Form 1.4 A sample of RCx Plan

### 3.3 Stage 2 – Investigation

The procedures and expected deliverables at investigation stage are shown as the following –

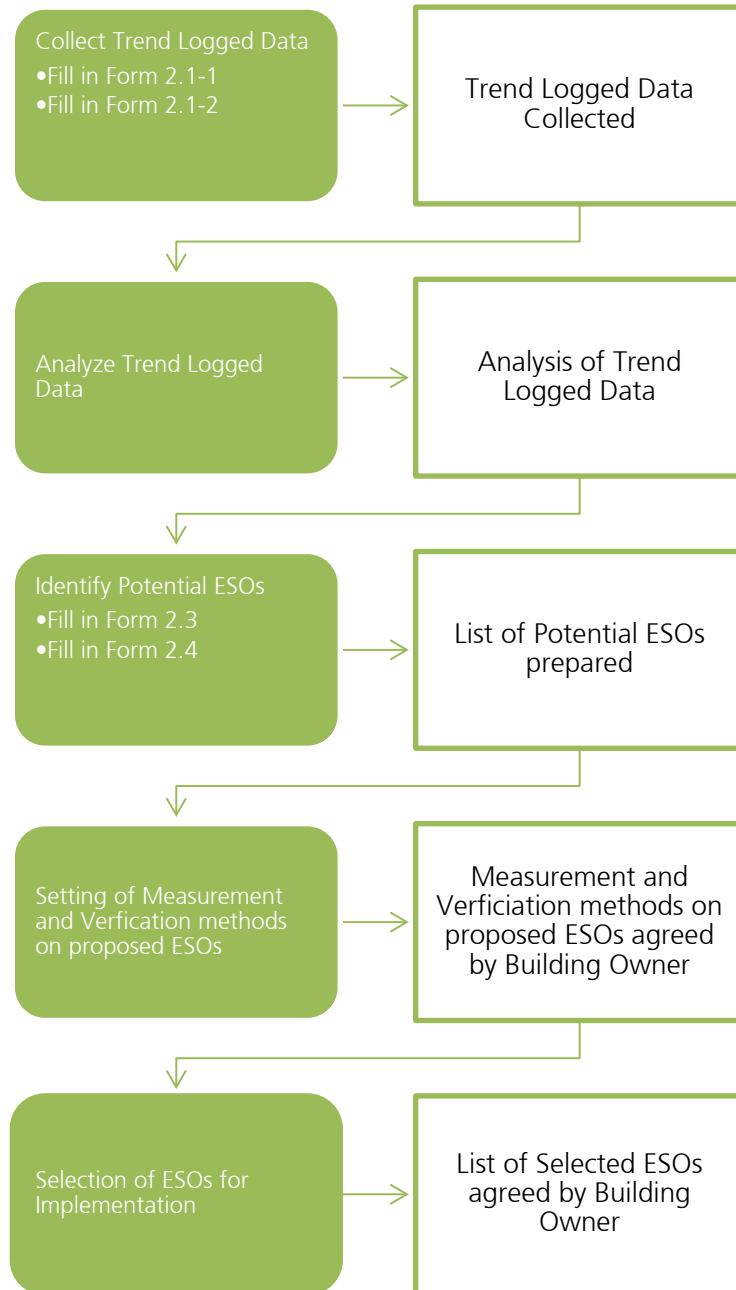

Fig. 3.3 The Flow Chart for Investigation Stage



### 3.3.1 Collection of Trend Logged Data

Diagnostic monitoring is the process of collecting data over time, at intervals ranging from one minute to one hour. RCx Team will collect the trend logged data by the building management system (CCMS), provided that it is installed in the building and the trend logged data is adequate and accurate enough for analysis. However, for those buildings without CCMS, or the CCMS has any limitations on storing or presenting the data, RCx Team can use portable data loggers to collect the data instead.

#### How Trend Logged Data is Collected by CCMS

- There are enormous amount of data ready to be collected from CCMS.
- Depending on the type of data and analysis methodology, the collect interval can be in minutes (i.e. 15 mins, 30 mins... ) to hourly.
- This can substantially reduce the amount of data to be processed and the work required.
- Data collection shall at least cover an operational cycle (a day, a week, a month...), depends on the operation of building
- Ideally The data would be collected throughout the whole year (four seasons) for annual analysis.

#### How Trend Logged Data is Collected by On-Site Measurement

- Typically the duration of such data collection is at least for a week for subsequent meaningful analysis;
- the data would be collected in the most probable season, where the most significant underlying operational problems would occur.

Form 2.1 provides a list of Instrumentation for Data Collection by Data Logger; Form 2.2a to 2.2g provides a sample of Data Collection Form.

### 3.3.2 Analyze Trend Logged Data

RCx Team will use the trend logged data to analyze the operational trends of energy consuming equipment/ systems and check whether there are rooms for improvements in operation.

For example, RCx Team will plot a number of trends for the trend logged data showing (1) the hourly, daily, weekly, or monthly trends, such as the hourly trend of the indoor air temperature in a room, and (2) how one parameter varies with the changes in another, such as how the total operating chiller capacity varies with the instantaneous cooling load.

From the charts, RCx Team will discover the ESOs which will possibly lead to inefficient energy use or poor indoor environment, such as the room air temperature is found always higher or lower than the set point, or the operating chillers' COP at night load becomes unacceptably low. Analyzing the trend logged data, the underlying operational problems are speculated.

### 3.3.3 Identify Potential Energy Saving Opportunities (ESOs)

When all the underlying operational problems are found with the help of equipment and system investigation test results, the ESOs can then be identified. RCx Team will develop a list of ESOs with details on estimated energy saving, payback period, implementation periods and anticipated interruption to normal services and the measurement and verification methods on energy saving. The steps of the energy saving calculation should be shown clearly to the building owner. Moreover, if the ESO requires to repair items, a list of proposed repairing items should be clearly shown to building owner for consideration.

Form 2.3 provides a List of Proposed Energy Saving Opportunities (ESOs)  
Form 2.4 provides a List of Proposed Repairing Items

### 3.3.4 Setting of Measurement and Verification Method of Energy Saving Opportunities (ESOs)

In each potential energy saving opportunity, a detailed energy saving estimation calculation should be reported to building owner. For the calculation method, consent should be made with the building owner so that RCx Team can re-calculate the actual energy savings under the agreed equation by the logged data after the implementation stage.

This verification method allows building owner to see the effectiveness of the Energy Saving Opportunities after implementation.

In case of using modelling for RCx, an energy model as it will provide accurate Measurement and Verification of before and after scenarios which can provide with trackable dynamic set of data.

### 3.3.5 Selection of Energy Saving Opportunities for Implementation

RCx Team will based on the cost-benefit analysis on the potential improvement and saving opportunities to discuss with the building owner for the recommended items to be implemented. Agreement should be made with building owner before implementation stage.



3.4 Stage 3 – Implementation

The procedures and expected deliverables in implementation stage are shown as the following –

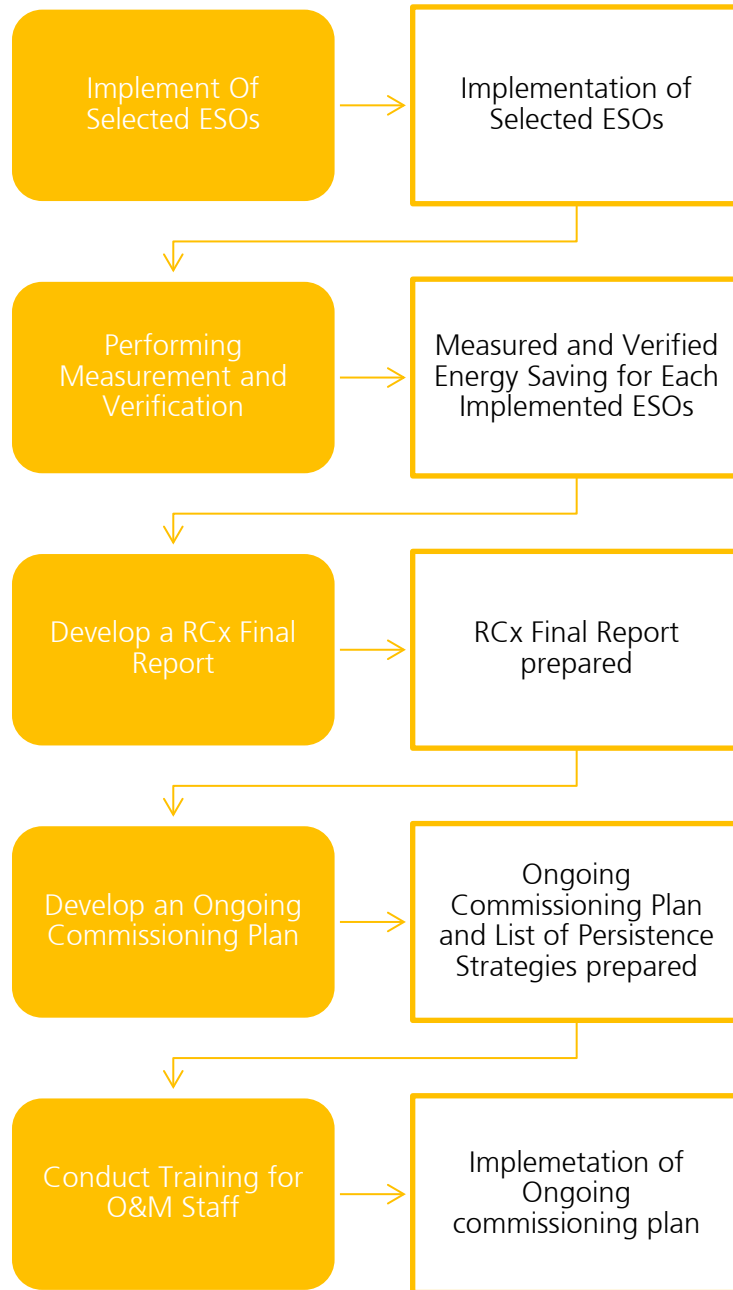

Fig. 3.4 The Flow Chart for Implementation Stage

### 3.4.1 Implement Selected Energy Saving Opportunities

The Selected Energy Saving Opportunities can be implemented by their own O&M staff. Otherwise, Building Owner may engage contractor to perform selected Energy Saving Opportunities and associated implementation work if required. In the implementation plan, a clear description for each ESOs should be presented. RCx Team can choose the most appropriate approach for rectification and then organize and define the work needed in the RCx implementation plan.

The building owner may choose propose a staged implementation plan to accommodate budget constraints or to minimize the interruption of system operation. Thus, RCx Team should liaise with the building owner and O&M staff to mutually agree the RCx implementation plan.

### 3.4.2 Performing Measurement and Verification

After carrying out the implementation of selected ESOs, RCx Team should collect back the post-implementation data and then verify the energy savings. **(For Measurement and Verification, please refer to 3.3.4 Setting of Measurement and Verification Method of Energy Savings Opportunities)** The post-implementation data are compared to the original baseline data and check whether the anticipated energy saving are attained or not.

The post-implementation data can be used to update the energy savings estimates as needed. Those data can also be used to establish a new baseline for the performance of that building system. Throughout the life of the equipment or systems, the new baseline can be used to establish criteria or parameters for tracking whether improvements are performing properly.

Fig. 3.4b shows the flow chart of implementation, measurement and verification stage

Fig. 3.4b Flow Chart of Implementation, Measurement and Verification Stage

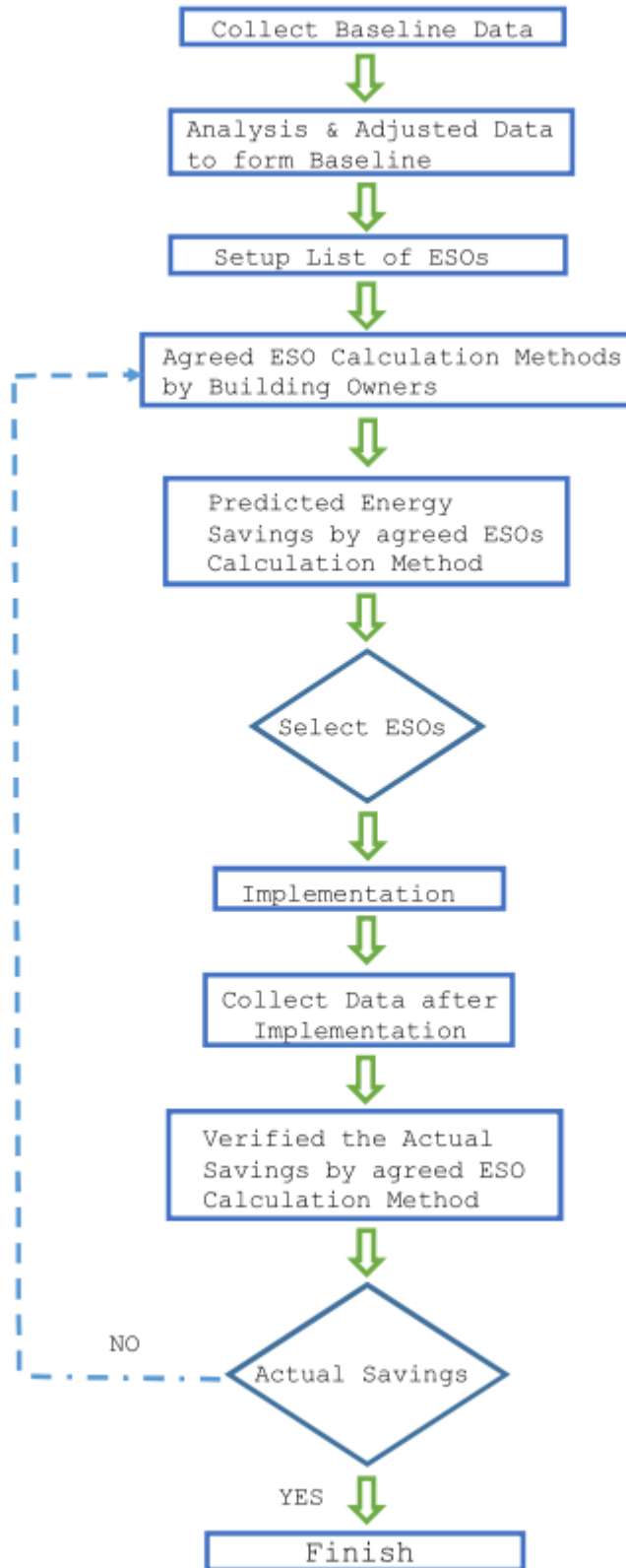

### 3.4.3 Develop a RCx Final Report

Final Report is a comprehensive record of the project which should become a part of the on-site resources for O&M staff. The specific contents of the Final Report should include but not limited to the followings:

- Executive Summary
- Owner's Operating Requirements
- The Findings Log with descriptions of the implemented measures
- Updated savings estimates and actual improvement costs
- The CCMS trending plan and data logger diagnostic/monitoring plan
- All completed equipment and system investigation tests and results
- Recommended frequency for re-commissioning
- Complete documentation of revised or new control sequences (or where this can be found)
- Recommendations for maintaining the new improvements
- Training Summary including training materials
- A list of capital improvements recommended for further investigation

### 3.4.4 Develop an Ongoing Commissioning Plan

In order to ensure the benefits of the Retro-commissioning project continue beyond the life of the project itself, RCx Team should assist the owner in determining the best strategies for keeping the new improvements efficiently over time. Below are the examples of viable strategies:

- Developing policies and procedures for updating building documentation
- Providing ongoing training for building staff
- Ensuring efficient operating performance
- Tracking energy and system performance
- Periodically recommissioning the building, paying close attention that the original RCx improvements are still producing benefits
- Instituting a plan of ongoing commissioning
- Continuously input operational data to the simulation model for energy use analysis and prediction. (for modelling) - optional

### 3.4.5 Conduct Training for O&M Staff

Building operators, managers and O&M staff should have right knowledge and skills to ensure the benefits of Retro-commissioning are maintained over the long-term. RCx Team should develop and conduct additional training for O&M staff at the end of the project with a view to providing an opportunity to address how staff can maintain the Retro-commissioning improvements. Below are the examples of trainings:

- A training session that involves a classroom workshop with some hands-on demonstrations on the building equipment
- Videotaped training for future reference and as resource for training new O&M staff.

### 3.5 Stage 4 – Ongoing Commissioning

The procedures and expected deliverables in Ongoing Commissioning stage are shown as the following –

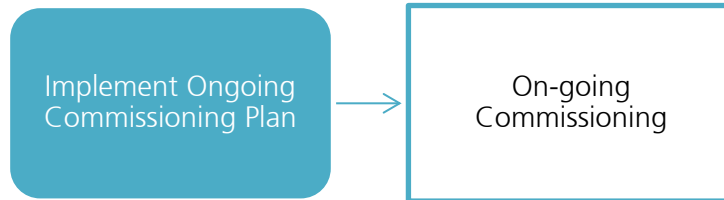

Fig. 3.5 The Flow Chart for Ongoing Commissioning Stage

In this stage, ongoing commissioning is focused on the persistence to maintain the building systems run in the most efficient manner. To achieve this, data are required to collect continuously and compare against the recommendation stated in previous RCx. The suggested persistence strategies are put in implementation to ensure the improvements continues. Ongoing commissioning shall be carried out every 3 to 5 years.

Samples of Key Performance Indicator:

1. Electricity Consumption Bill
2. EUI
3. Plant COP
4. User Complaints
5. Building Occupancy Over Design Value
6. CO2 Concentration Over Design Value
7. Indoor Temperature Over Design Temperature
8. Lux Level

RCx Team should help set up the baseline after implementation stage. The baseline values should act as key performance indicators and compared with the building conditions yearly.

If there is a large difference between the baseline data and the collected data, retro-commissioning process should be carried out again.





### 3.6 Applications of Energy Modelling in RCx (Optional Method )

To check where the greatest improvement and energy saving opportunities in existing building, it can be determined by reviewing which energy consuming equipment/ systems consume the most energy.

If there is sub-metering installed in different types of energy consuming equipment/ systems in the building, we could know the breakdown of annual building energy consumption for each equipment/ system.

However, many of the existing buildings in Hong Kong do not have such sub-metering provisions. In such case, the computerized energy simulation tools in the market can be used to simulate an energy models based on the existing system information, operation schedule and electricity bills.

Modelling can also benefit to RCx while data is available, this allows the operational data to be used for a number of energy modelling strategies that will further enhance the RCx process and should therefore be included in more detail;

- (1) Utilise operational data to refine energy model predictions and therefore refine more accurately cost reductions as a result of analysing various energy saving proposals.
- (2) Provide an energy model that once updated with recent operational data, will provide an accurate benchmark that will provide the means for comparison when completing continuous commissioning.
- (3) Perform measurement and verification studies to identify accurately the savings that can be generated as a result of an energy saving proposal.
- (4) Provide a high value asset to the client with respect to the energy model, and results of the M&V process that can be adopted on future project for the purpose of design, or RCx.

In general, applications of energy modelling in RCx including:

- (1) Evaluate the breakdown of energy use for the existing building accurately;
- (2) Identify the gap between the simulated results and the energy bill; and
- (3) Estimate the amount of energy cost saving for selection of the identified opportunities.



3.6.1 Benefits and considerations

Energy modelling can bring about a number of benefits for long term Retro-commissioning:

- (1) Simulation can complete the details of energy consumption even though there is only limited data. Since sub-metering may not be available for all energy consumer, in order to reasonably predict the energy use for different building systems, energy model can be used to complete the energy break down based on the available information as well as the electricity bills. Furthermore, whole year energy consumption of different building systems can also be predicted even if there are only a few days information available.

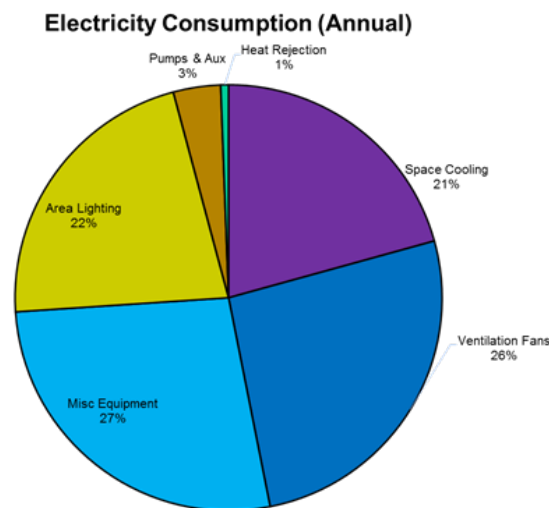

Fig. 3.6.1.1a Sample pie-chart of the energy consumption for various BS systems

**Electricity Consumption of HVAC Systems (Annual)**

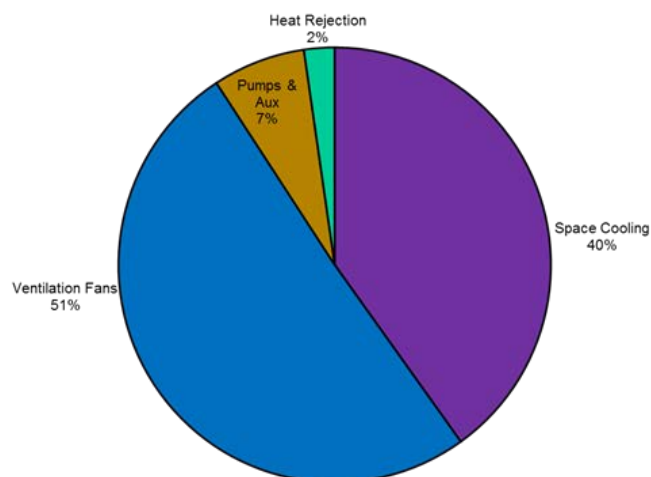

Fig. 3.6.1.1b Sample pie-chart of the energy consumption for various HVAC systems



- (2) Simulation can predict the energy use even if no information is available for one of the existing building systems. Professional assumption can be made for inputting into the energy model, and based on the previous electricity bills and all available information for other building systems, the energy consumption of those building systems can still be estimated and hence identifying the opportunities for improving the efficiency of the building systems.

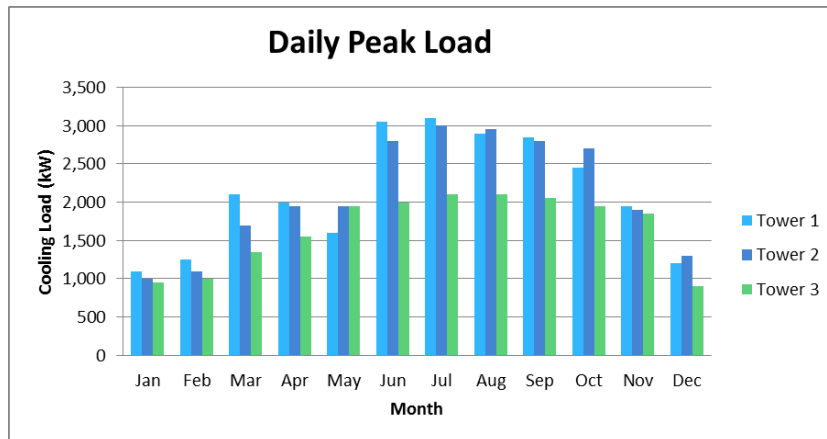

Fig. 3.6.1.2 Sample diagram of Daily Peak Cooling Load

- (3) Energy model can be utilized for estimating the potential payback from ESOs. Energy model established for the energy breakdown can be used subsequently as a baseline model, for performing the parametric analysis to help estimating the amount of energy cost saving for the potential ESOs, which are identified in the investigation stage. This helps estimating the payback period of each opportunities and hence assisting the building owner to select the most cost effective ESOs for implementation.

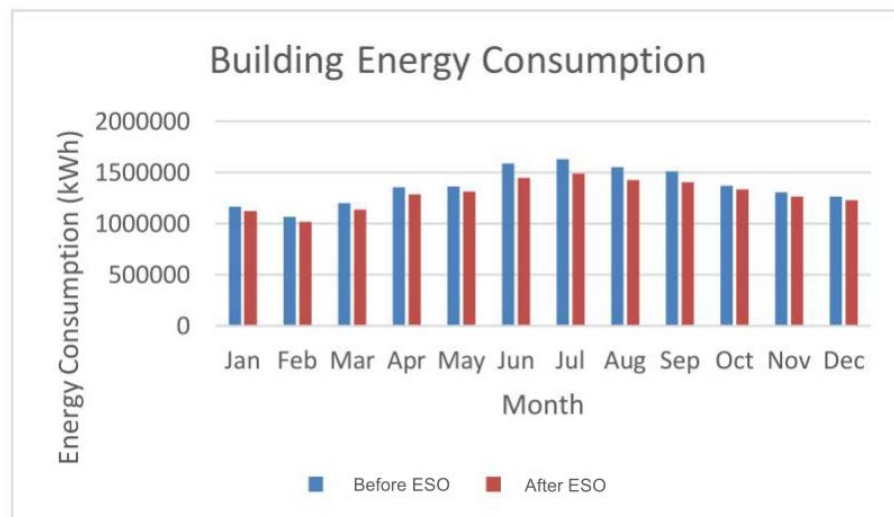



Fig. 3.6.1.3 Prediction of monthly building energy consumption before and after implementation of Energy Saving Opportunities (ESOs)

- (4) Base model can also be used for identifying any malfunction equipment or improper operation of building systems. When comparing the energy consumption of the base model with the electricity bill, if the latter has an apparently higher energy consumption, it can be concluded that some of the building systems are not operating properly or some of the equipment, such as sensors, are malfunction, hence conducting remedies to optimize the system back to the efficient operating condition.

Although energy modelling provides a platform for monitoring the energy efficiency of the building, there are some considerations that have to be aware before establishing the simulation:

- (1) Availability of the information for simulation. Although energy model can be prepared even if no information can be obtained for some of the building systems based on the previous electricity bills, with professional assumptions for inputting these systems, the accuracy of the energy model will be affected, which leads to incorrect estimation of energy saving for the proposed ESOs. Therefore, it is necessary to collect the below information for establishing the model:
  - a. Building information (e.g. architectural layout, elevations, floor area, shape, floor to floor height, number of storey, orientation, type of usage)
  - b. HVAC configuration and operation (e.g. MEP layout, pump and fan flow rate, temperature set point, system type, operation schedule)
  - c. Equipment efficiency (e.g. chiller COP, pump efficiency, fan and motor efficiency; boiler efficiency)
  - d. Lighting, equipment power density, Miscellaneous load (i.e. lift & escalator, water pump, exterior lighting, domestic hot water)
  - e. Adoption of energy saving measures, i.e. renewable energy, heat recovery, demand control ventilation, daylight, motion sensor
- (2) Additional manpower for energy simulation. Although there are a number of benefits for preparing the energy model, it may lead to additional cost and manpower for modelling. However, considering the long term effectiveness on



identifying the inefficient operation of the building as well as quick evaluation of energy saving and payback period of different ESOs, it is worthwhile to conduct the energy modelling in RCx.

## Appendix A

### Sample Technical Approach for Identification of Energy Saving Opportunities (ESOs)

### **Sample Technical Approach for Identification of Energy Saving Opportunities (ESOs)**

The examples demonstrated in this section are not meant to be definitive or exhaustive. In the course of RCx some possible energy saving opportunities (ESOs) and/or building operational improvement could be identified. The RCx Team will carefully discover the genuine underlying operational problem in their own analysis of the trend logged data.

Energy saving opportunities (ESOs) may involve different building services systems/installations but not limited to:

1. Air-conditioning (Central Chiller Plant);
2. Air-conditioning (Heat Rejection System);
3. Air-conditioning (Air-Side System);
4. Air-conditioning (Water-side System);
5. Electrical System;
6. Lighting System; and
7. Others

Below are different Technical Approach for Identification of Energy Saving Opportunities (ESOs).

*Acknowledge Hong Kong Green Building Council for providing certain examples on RCx.*

## Example 1 - Air-conditioning (Chilled water plant)

Energy Saving Opportunity:  
Chiller Sequencing Optimisation – More chillers operated at partial load

### Background Information

The building is served by 4 sets of VSD air-cooled chillers (3 duty & 1 standby) with 4 sets of chilled water pumps (3 duty & 1 standby). The chilled water configuration is a differential pressure bypass system with variable speed drives for adjusting the speed of chilled water pumps.

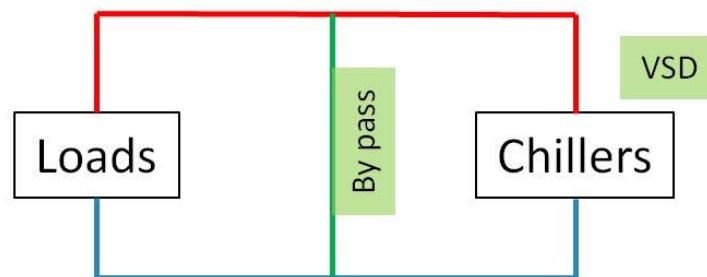

Simplified schematic (For indicative only)

### Facility / Equipment

Chillers

### Site Measurement, Observation and Findings

Figure 1a below shows a graph with y axis showing the % of full load ampere FLA, of the individual chillers in operation and the x axis showing the % of the cooling load of the whole plant. The yellow dotted line is a hypothetical line indicating a direct proportional relationship between the % FLA of individual chillers with the % loading of the various chiller combination. This line is used as a rough reference indicating on how different chiller combination is performing at various loading.

The operating data between the overall loading range 25% to 70% were entered into the graph.

The followings were observed:



1. Two chiller combinations ( 2 chillers and 3 chillers ) have been used between an overall loading of 30%-50% loading.
2. When the two chiller combinations were operating at near full load, the % FLA remains at 1 (100%) instead of a corresponding drop in % FLA following the dotted reference line.
3. The FLA at a lower % part load was lower than the reference line. This indicated the chillers were operated at a higher efficiency during part load condition. The performance curve by the manufacturer Figure 1b, conformed this finding

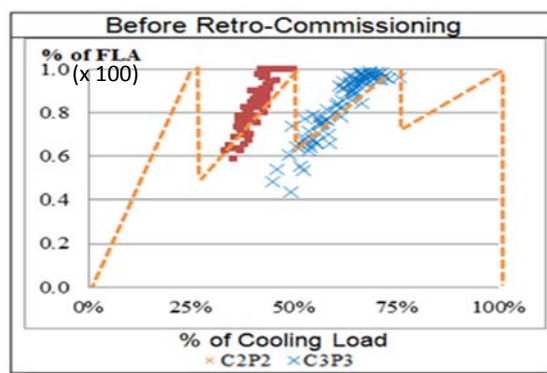

Figure 1a

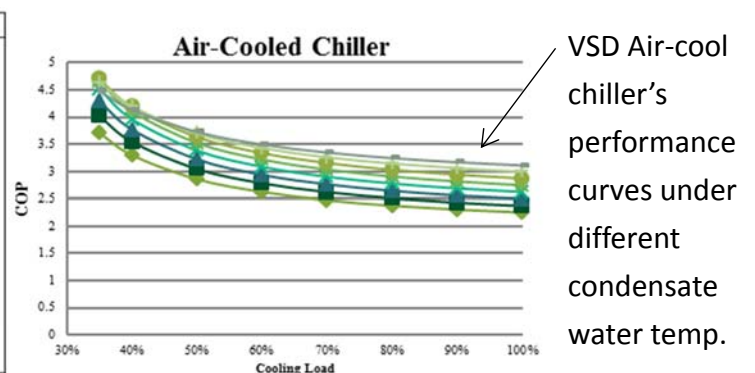

Figure 1b

### Recommendation

It is recommended to operate a 3 chillers combination to cater percentage of load down to 40% and a 2 chillers combination to cater the percentage of load down to 30%.

Figure 1c shows the performance after adopting the above strategy.

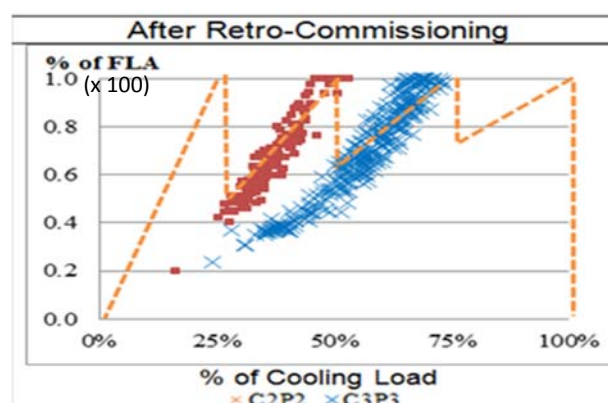
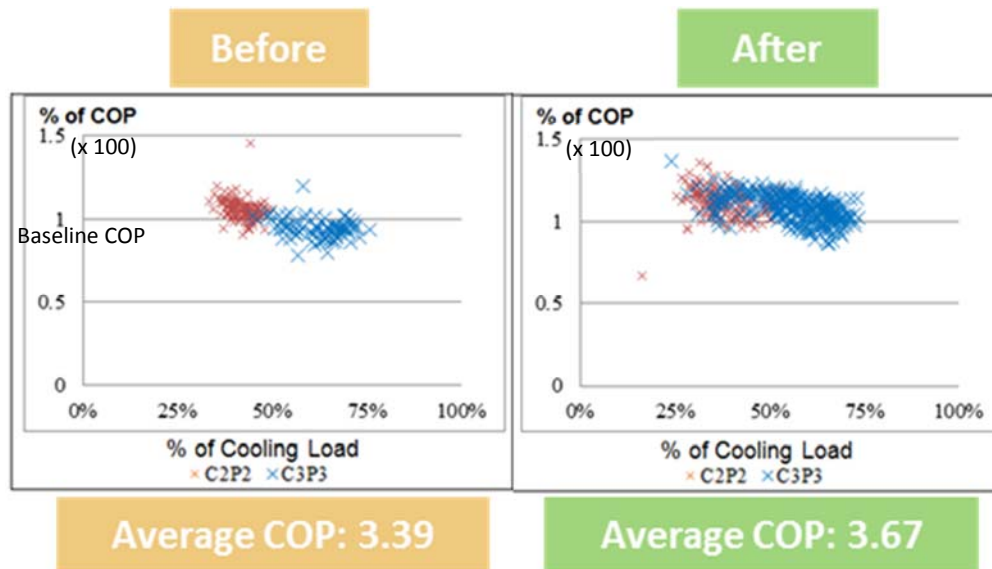

Figure 1c

### Energy Saving Estimation:

As shown in Figure 1d, the implementation of chiller sequencing improvement, the efficiency (COP) of the two combinations has been improved by 8.2% on average. It is estimated that the annual energy saving would be around 4.8%.



Remarks:

100% of COP = Baseline COP (before RCx) = 3.39

108.2% of COP = Improved COP (after RCx) = 3.67

## Example 2 - Air-conditioning (Chilled water plant)

### Energy Saving Opportunity:

Adding a standby mode to prevent the activating of low-cut function of the oil-free chiller at light load operation

### Background Information

The building is served by 2 sets of air-cooled chiller (1 duty & 1 standby). One of the chillers is an oil-free centrifugal chiller (the duty chiller - new) with 2 compressors and the other one is an air-cooled screw chiller (the standby chiller - old) with 4 compressors. The minimum load capacity of the compressor is about 20-30% . The chilled water configuration is a differential pressure bypass system with same number of constant speed chilled water pumps as the chillers.

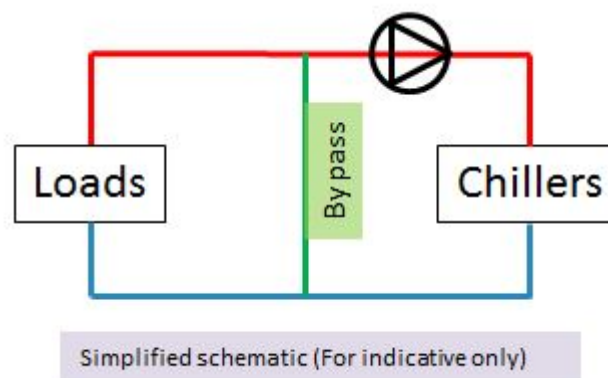

### Facility / Equipment

Chillers

### Site Measurement, Observation and Findings

1. During peak seasons, the oil-free chiller were only running at about 50-60% of it's rated capacity.
2. Because it is a constant pump speed differential pressure bypass system, the chilled water temperature difference is only about 3 deg C or below resulting from the large amount of chilled water needed to be bypassed back to the chiller.
3. When the ambient temperature drops to below 20 deg C, the cooling load will fall to <15% and trigger the "low-cut" protection of the chiller. To prevent tripping the oil

free chiller, the practice is to operate the air-cooled screw chiller during those light load conditions which decreases the efficiency of the plant. Figure 2b below shows the comparison between the efficiency of the oil free chiller and the screw chiller

Before Retro-commissioning

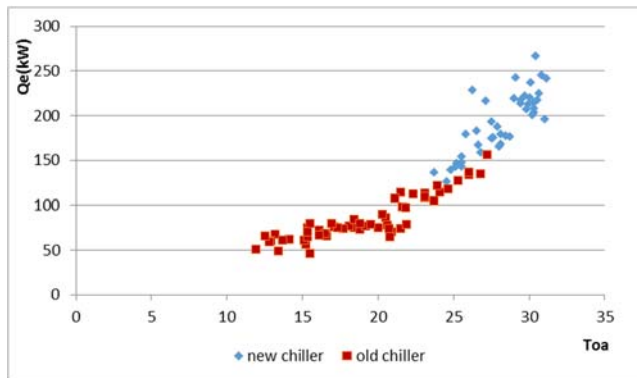

Qe(kw) – Cooling Load

Toa – Outdoor ambient temperature

Figure 2a

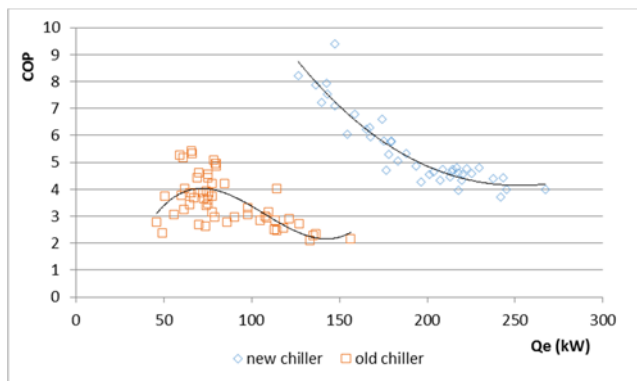

Figure 2b

### Recommendation

Two suggestions were proposed:

1. maintain the chilled water temperature difference across the chiller not less than 5 deg C by converting the system to primary variable flow (this will be implemented at a later stage)

- work with the chiller manufacturer to modify the low temperature cut control so that the chiller will be switched to standby mode (with the compressor stopped ) instead of tripping the chiller when the chiller water is lower than the cut-off temperature. The compressor will automatically cut-in when the chilled water temperature has raised to the normal operating temperature range of the chiller. This has eliminated the need to use the screw chiller and hence increased the overall efficiency of the chiller plant.

### Energy Saving Estimation:

After the implementation of the above recommendation, the oil free chiller can be operated when the ambient temperature is below 20 deg C . Figure 2c & Figure 2d compares the performance before and after the implementation.

After Retro-commissioning

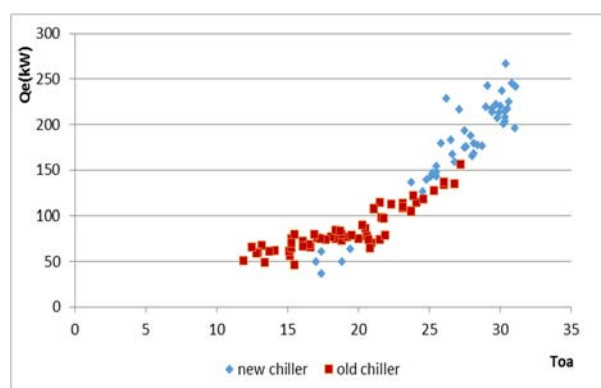

Figure 2c

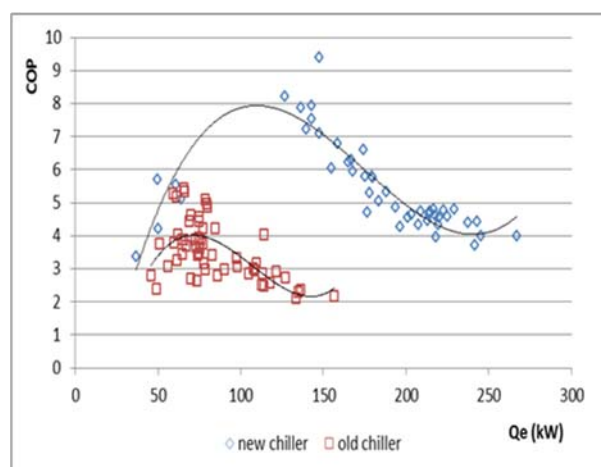

Figure 2d

Example 3- Air-conditioning (Central Chiller Plant)

**Energy Saving Opportunity:**  
 Adjust the chiller’s load factor by CHWST setpoint reset in order to improve chiller efficiency.

**Background Information**

In a building, there are 2 sets of water-cooled chillers (1 no. 350kW Constant Speed Drive (CSD) screw type chiller and 1 no. 350kW Variable Speed Drive (VSD) screw type chiller served for the whole building. Based on different cooling load, the CSD chiller and the VSD chiller will be operated together.

**Facility / Equipment**

Chiller No.1 (350kW CSD screw type chiller) and Chiller No.2 (350kW VSD screw type chiller)

**Site Measurement, Observation and Findings**

- Trend logging of chilled water flow rate;
- Trend logging of chilled water temperature differential; and
- Trend logging of power input for operating chiller plant equipment

By the above collected data, existing chiller load distribution was found as the following:

	Jan	Feb	Mar	Apr	May	Jun	Jul	Aug	Sep	Oct	Nov	Dec
Outdoor Air Temp (deg C)	16	15.5	17.5	23.6	26.7	29.4	29.8	28.4	27.9	26.8	22.3	19.6
Building Cooling Load (kW)	211	222	229	422	457	510	528	535	524	457	394	239

Table 3a) Weather Data in 2016 (obtained from HKO) and one building cooling load in 2016

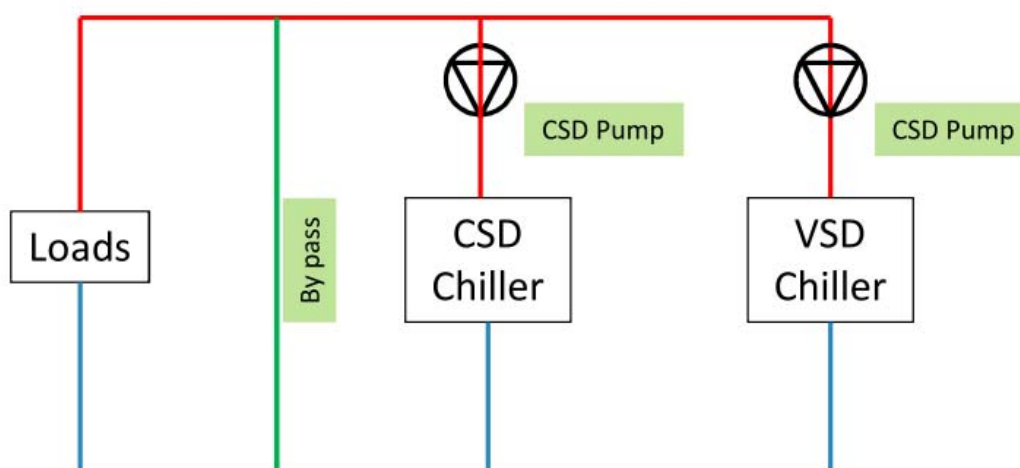

Figure 3a) Simple Block Diagram for the Plant System

	Chiller 1	Chiller 2
Type of Chiller	CSD	VSD
Existing CHWST Setpoint	7 deg C	7 deg C
Existing Distribution of Chiller Average Load Factor	60%	60%

Table 3b) Existing Chiller Load Distribution

	Jan	Feb	Mar	Apr	May	Jun	Jul	Aug	Sep	Oct	Nov	Dec
Chiller 1 (CSD) COP	NA	NA	NA	4.04	3.97	3.56	3.56	3.56	3.56	3.97	3.85	NA
Chiller 2 (VSD) COP	5.36	5.36	4.8	4.19	4.38	3.81	3.68	3.68	3.68	4.38	4.64	6.22

Table 3c) Monthly COP Figure Before CHWST Setpoint Reset

Based on the properties of CSD and VSD chiller, it is observed that CSD has a higher COP near full load condition while VSD has higher COP near its part load condition. Thus, chiller load distribution should be properly adjusted so that CSD chiller can bear more loading while VSD chiller bear less loading. As a result, the overall COP of chiller plant would be improved.

A COP graph of chiller should be obtained from chiller supplier as this is an essential tools to review chiller load factor.

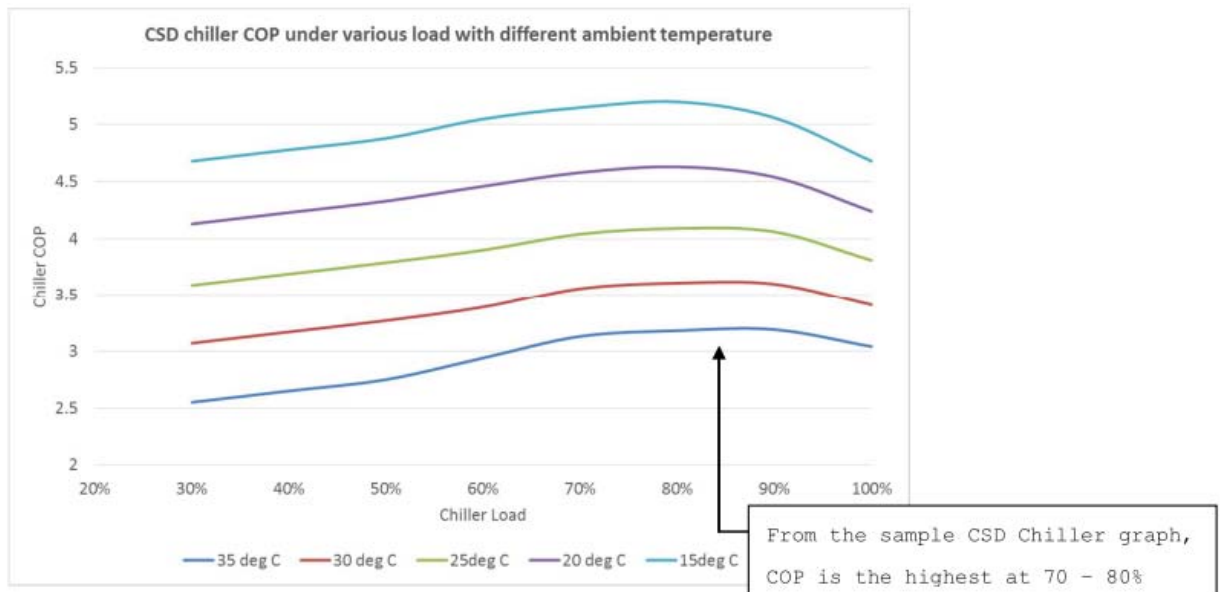

Fig 3b) Sample COP graph of 350kW CSD Air Cooled Screw Type Chiller

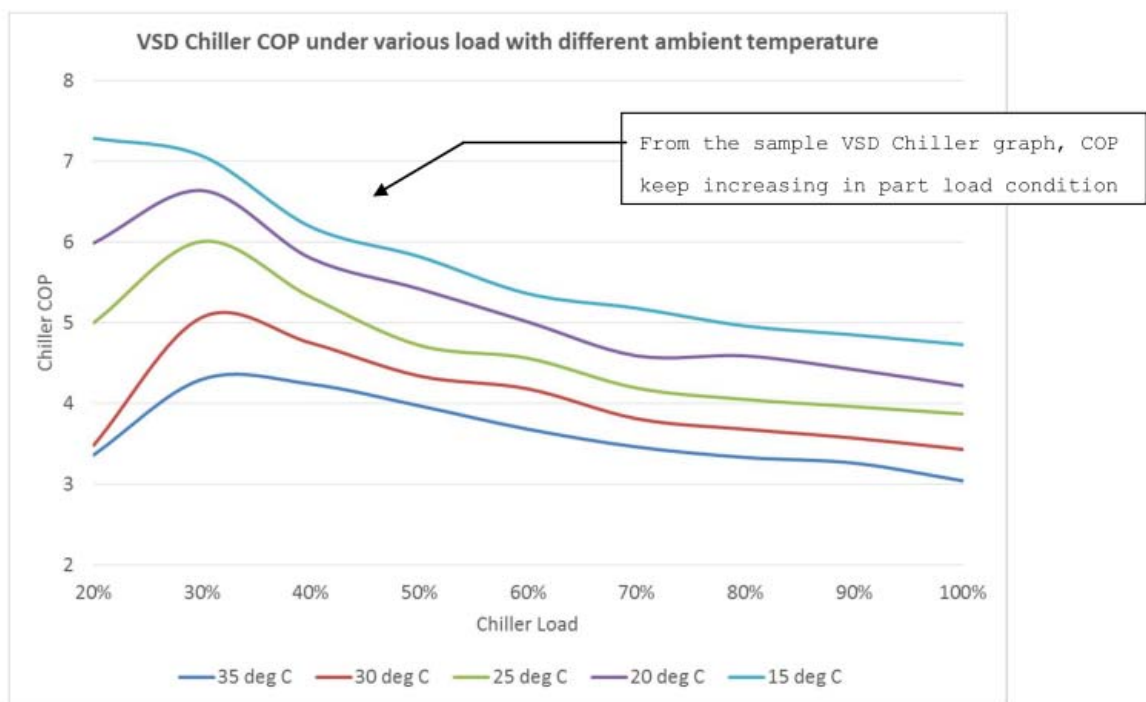

Fig 3c) Sample COP graph of 350kW VSD Air Cooled Screw Type Chiller

### Recommendation

In order to capture the higher COP range, It is recommended to reschedule the load so that CSD chiller can bear more loading while VSD chiller bear less loading so as to improve their overall COP. We can observe from Fig 3b) and Fig 3c) that Chiller 1 and Chiller 2 can operate at higher COP with the proposed chiller Load Distribution according to Table 3b.



	Chiller 1	Chiller 2
Type of Chiller	CSD	VSD
Proposed CHWST Setpoint	6.5 deg C	7.5 deg C
Proposed Distribution of Chiller Average Load Factor	70%	50%

Table 3d) Proposed chiller Load Distribuion

	Jan	Feb	Mar	Apr	May	Jun	Jul	Aug	Sep	Oct	Nov	Dec
Chiller 1 (CSD) COP	NA	NA	NA	4.07	4.07	3.61	3.61	3.61	3.61	4.07	3.97	NA
Chiller 2 (VSD) COP	5.36	5.36	4.8	4.56	4.64	4	4	4	4	4.64	4.72	6.22

Table 3e) Monthly COP Figure After CHWST Setpoint Reset

### Energy Saving Estimation

- Chiller No.1 and Chiller No.2 operating for the period from April to November
- Chilled water supply temperature reset as the above table 3e)
- Operating in office hours  
Mon-Fri: 0800 to 1800
- Estimated Annual electricity consumption of the two chillers before RCx:  
353,370kWh
- Estimated Annual electricity consumption of the two chillers after RCx:  
343,450kWh

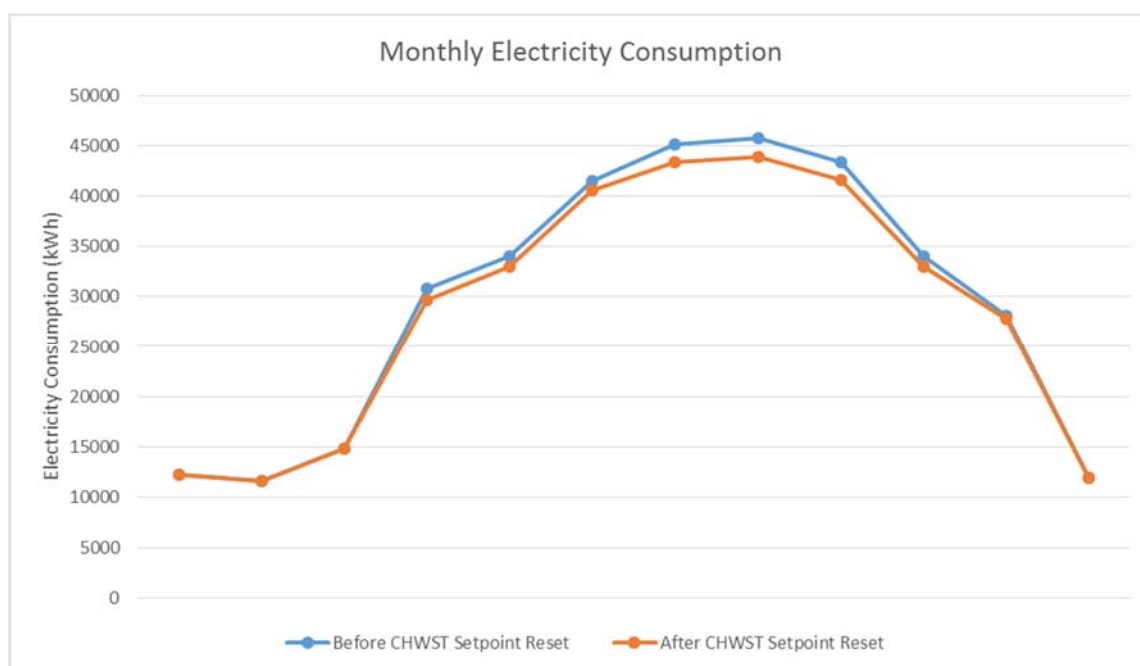

Figure 3d) Monthly Electricity Consumption Before and After CHWST Setpoint Reset

**Annual electricity consumption saving= 9,920kWh (~3% of annual chiller electricity consumption)**

There are still rooms for further adjustments in the implementation stage which may increase the energy savings of this strategy.

#### Example 4- Air-conditioning (Central Chiller Plant)

**Energy Saving Opportunity:**  
Evaluating existing chiller plant performance with retrofitting consideration

#### Background Information

In June, when the ambient temperature was around 30 deg C, all 4 chillers were in operation since some of the compressors of chillers are out of order and under maintenance. The chillers are always operating at 85% of full load ampere (FLA), which is the maximum limit, with all workable compressors of chillers were in operation, as shown in Figure 4a. Under such operating condition, the chilled water supply temperature was unable to meet the set-point of 8.5 deg C.

On the other hand, the differential pressure bypass valve always kept partially opened even the isolating valves on the bypass pipe were manually closed. Hence, a portion of chilled water supplied from the chillers will flow back to the chillers again via the bypass pipe. As a result, the differential temperature of chilled water was about 3.5 deg C or below as shown in Figure 4b, which represents the cooling output is about 60% or less when constant flow through chillers.

Since the constant flow chilled water pumps were connected directly to individual chillers without through a common header, this configuration reduced the flexibility in controlling the flow through chillers (e.g. 3 pumps 4 chillers is not available) during operation, especially when some of the compressors of chillers were under maintenance.

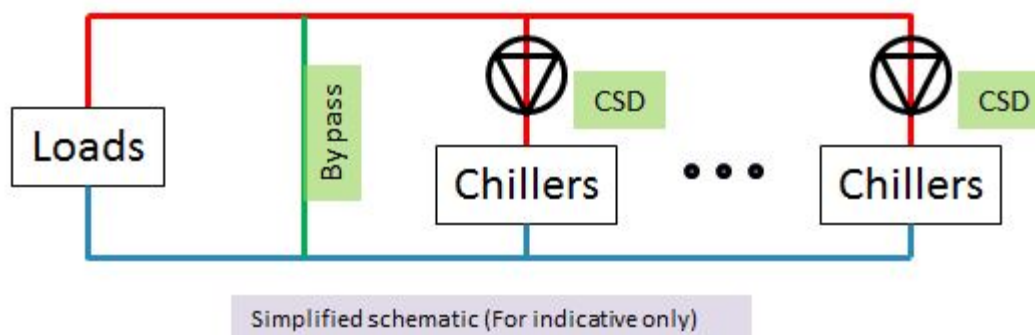

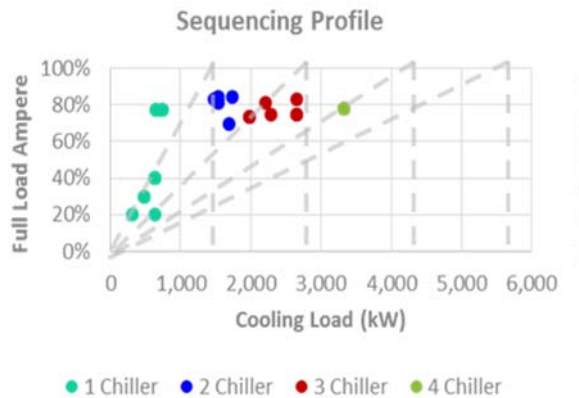

Figure 4a

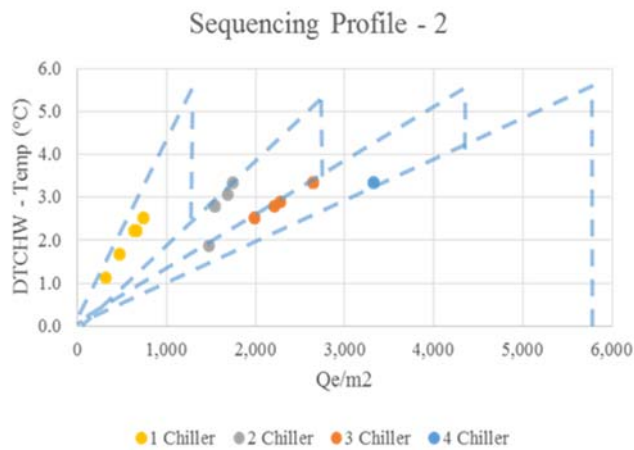

Figure 4b

### Facility / Equipment

The building is served by 4 sets of air-cooled reciprocating chiller (3 duties & 1 standby) with 4 sets of chilled water pumps (3 duties & 1 standby). Each chiller is equipped with 4 compressors. The chilled water system configuration is a differential pressure bypass system and each chilled water pump is directly connected to individual chillers (i.e. constant flow through chillers).

### Site Measurement, Observation and Findings

1. The chillers have been in operation for more than 20 years and a number of chillers were under servicing during the site inspection
2. Chilled water supply temperature cannot meet the 8.5 deg C set point.
3. From Figure. 4a more chillers than required were needed to cater for the loading.
4. Figure. 4b indicated a very low chilled water temperature difference (< 3 deg C) across the chillers indicating chilled water has been bypassed through the differential pressure bypass valve.
5. Operators have set a 85% FLA limit to the chillers to prevent it from breaking down.

The above has indicated that the chillers were already too old and have been significantly deteriorated.

### Recommendation

The following suggestions were recommended:

1. To replace the chillers. A study to evaluate the various replacement options is shown at the following session.
2. To convert the chilled water system to a variable flow system. It needs to connect the chilled water pumps with a common header, and install variable speed drives on all chilled water pumps.

Client agreed to perform major retrofitting work, hence a scenario analysis was carried out (as shown in Table 4a) based on the original case (i.e. all 4 chillers are undertaken replacement). Results indicated that if all chillers are replaced, the estimated payback period will be 9-10 years. For Option 1 & Option 2, the payback period will be shortened to 8 years and 6 years respectively if only some of the chillers were replaced. However, with Option 2 (only replacing 2 chillers), there will only be 10% less energy saved annually in comparison with the original case. Option 3, i.e. replacing with only 2 chillers of higher cooling capacity, is recommended. This option can achieve a higher energy saving with shorter payback period. In conclusion, the scenario analysis suggested that it is crucial to consider the building's actual operation profile as well as efficiency of the HVAC system to determine a retrofitting plan.

Technical Guidelines on Retro-commissioning  
 Appendix A – Sample Technical Approach for Identification of Energy Saving Opportunities (ESOs)

	<b>Original</b>	<b>Option 1</b>	<b>Option 2</b>	<b>Option 3</b>
Chiller	4 x 400 TR Air-cooled (VSD)	3 x 400 TR Air-cooled (VSD)	2 x 400 TR Air-cooled (VSD)	2 x 450 TR Air-cooled (VSD)
Estimated Payback	9-10 years	8 years	6 years	5.5-6 years
Annual Saving (kWh)	1,365,000	1,365,000	1,210,000	1,490,000

Table 4a

### Example 5 - Air-conditioning (Central Chiller Plant)

**Energy Saving Opportunity:**  
To upgrade chiller plant control system in order to improve energy efficiency operation

#### Background Information

In a building, the central chiller plant is comprising 1 set of 1000 kW air-cooled screw type chiller and 2 sets of 1000 kW heat recovery screw type chillers for day-mode or high-demand operation time. The chiller plant for day-mode operation is a secondary loop design with operating of primary and secondary chilled water pumps deliver the chilled water in the system (i.e. 4 nos. of 9.0kW primary pumps and 3 nos. of 34.0kW secondary chilled water pumps).

In night mode operation, 2 sets of air-cooled packaged screw heat pumps (300 kW) are operated with 3 nos. of 9.0 kW primary chilled water pumps in differential bypass design.

#### Facility / Equipment

Central chiller plant

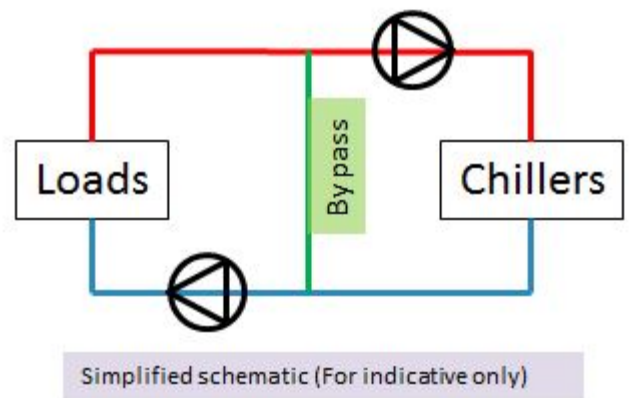
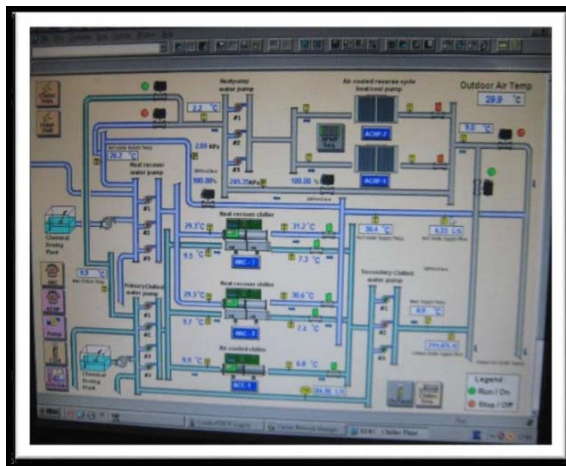

### Site Measurement, Observation and Findings

The flow meters could not provide accurate and reliable readings and the control logic of the existing chiller plant could not be revealed or identified in the documents. Also, there is no saved record on the logging of operating data for analysis of past performance on the chiller plant.

Inconsistencies are found between the on-site measurement of the chilled water flow and the readings from the control and monitoring system of existing chiller plant. As such, the plant is not monitoring the actual demand and providing appropriate control functions based on the realistic situations.

### Recommendation:

To repair/replace the water flow sensors together with the automatic control system of the chiller plant so as to identify the actual load profile and develop a proper control sequencing programme to meet the cooling demand with adjusted chiller performance.

### Energy Saving Estimation:

- Chilled water temperature reset (1.5 deg C) for day mode operation (Dec to Apr)
- Reduction of operation for extra secondary chilled water pump (3 hrs saving per day on weekday from Jun to Nov)
- Adjusted operation of night mode chiller for equipment cooling (Dec to Apr)
- Prevent extra pump operation of night mode chiller (May to Nov)

**Annual electricity consumption saving = 10,000 kWh (a) + 7,300 kWh (b) + 68,000 kWh (c) + 8,000 kWh (d) = 93,300kWh**

Remarks:

- (a) Chilled water temperature reset for day mode operation
- (b) Reduction of operation for extra secondary chilled water pumps
- (c) Refine the operation of night mode chiller for equipment cooling
- (d) Reduction of extra night mode chilled water pumps



## Example 6 - Air-conditioning (Heat Rejection System)

### Energy Saving Opportunity:

Optimisation of Cooling Tower to reduce the condensing water entering temperature of chillers

### Background Information

The building is served by 4 sets of centrifugal chiller (2 duty & 2 standby) with associated fresh water cooling towers and condensing water pumps connected in a one-to-one basis. The cooling towers, condensing water pumps and chillers are connected in series to common headers. Variable speed drives are installed for speed control of cooling tower fans.

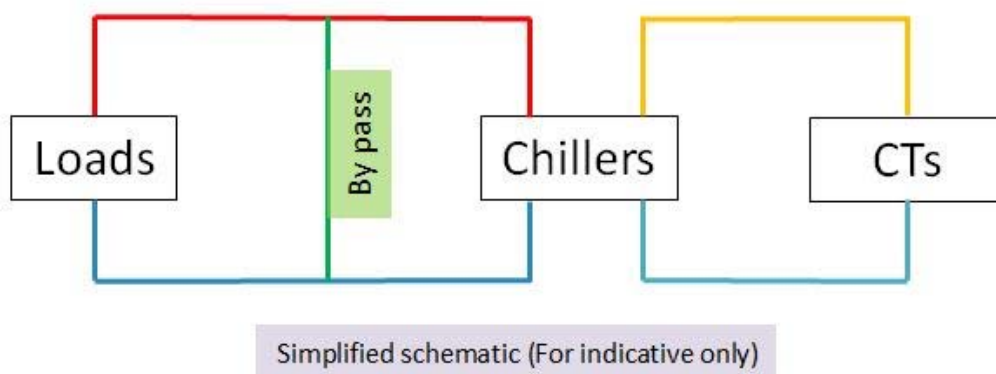

### Facility / Equipment

Cooling tower and condensing water pump

### Site Measurement, Observation and Findings

The approach temperature of cooling towers ranges from 6 deg C to 12 deg C. while the condensing water entering temperature has not dropped to below 26 deg C even when the wet-bulb temperature falls to below 20 deg C as shown in Figure 6a & Figure 6b.

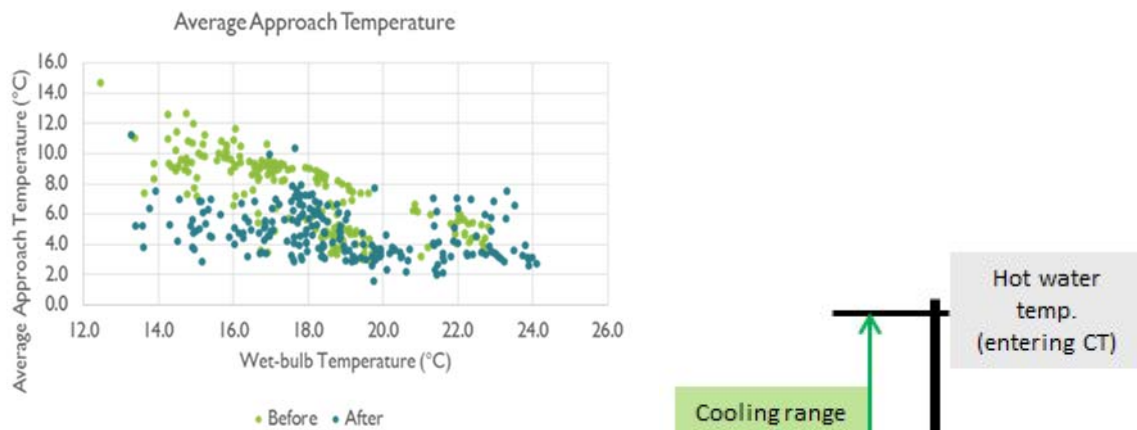

Figure 6a

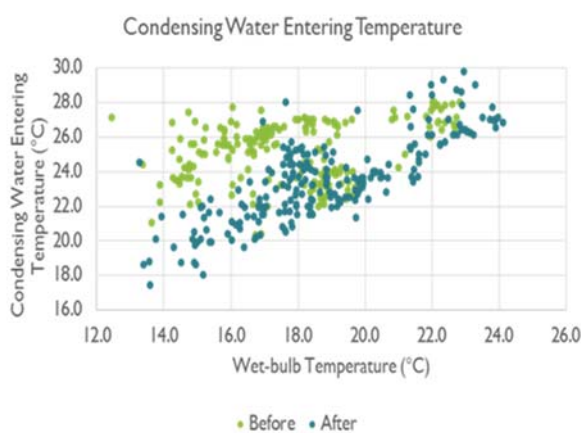

Figure 6b

### Recommendation

The objective is to decrease the approach temperature during periods with lower wet-bulb (e.g 14 deg C to 28 deg C) to within the proposed 2 deg C to 8 deg C . The condensing water entering temperature, which equals to the sum of wet-bulb temperature and the approach temperature of cooling tower, should be able to drop from 30 deg C (28+2) to 22 deg C (14+8).

To achieve the lowering of the approach temperature ,it is recommended to control the condensing water entering temperature from 30 deg C to 22 deg C by varying the number of cooling towers ( instead of on one to one base)and the speed of the cooling tower fans.

A proposed value of the approach temperature is worked out based on the performance data of the cooling towers. When the average approach temperature is higher than the

recommended value, one more cooling tower will be called on and the cooling tower fan speed will start from 30 Hz and will be increased when the approach temperature still cannot meet the recommended value.

### Energy Saving Estimation:

After the implementation of the above strategy, the power of cooling towers was increased by 5kW on average as shown in Figure 6c and the chiller power consumption was reduced by 10kW as shown in Figure 6d. The estimated annual energy saving of 3.2% of the chiller plant can be achieved annually.

There are still rooms for further adjustments in the coming months which may increase the energy savings of this strategy.

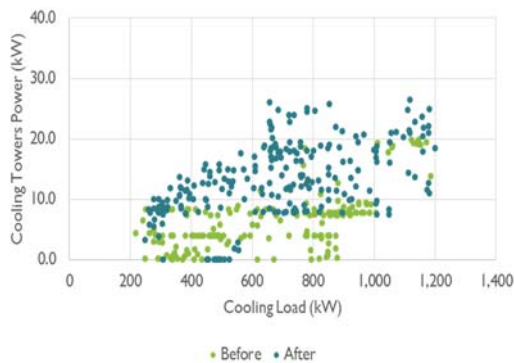

Figure 6c

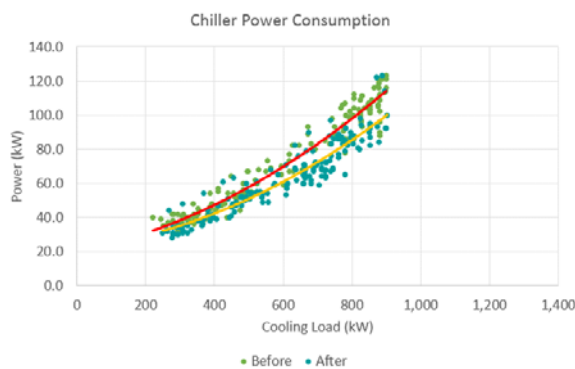

Figure 6d

### Example 7 - Air-conditioning (Air-side System)

**Energy Saving Opportunity**  
To adjust indoor room air temperature thermostat

#### Background Information

In an office, VAV system is served to the perimeter zone while CAV system is for internal zone. The AHU supply air temperature is 15 deg C while the thermostats for the space are set at 15 deg C.

#### Facility / Equipment:

Indoor air temperature thermostat

#### Site Measurement, Observation and Findings

-Trend logging of indoor air temperature

The indoor air temperatures are plotted against time. From the below graph it is found that the indoor air temperature in average is lower than the suggested set point of 24-25.5 deg C. (Green Part indicates the office hour). It is found that user block the air diffuser in certain zone due to too low supply air temperature.

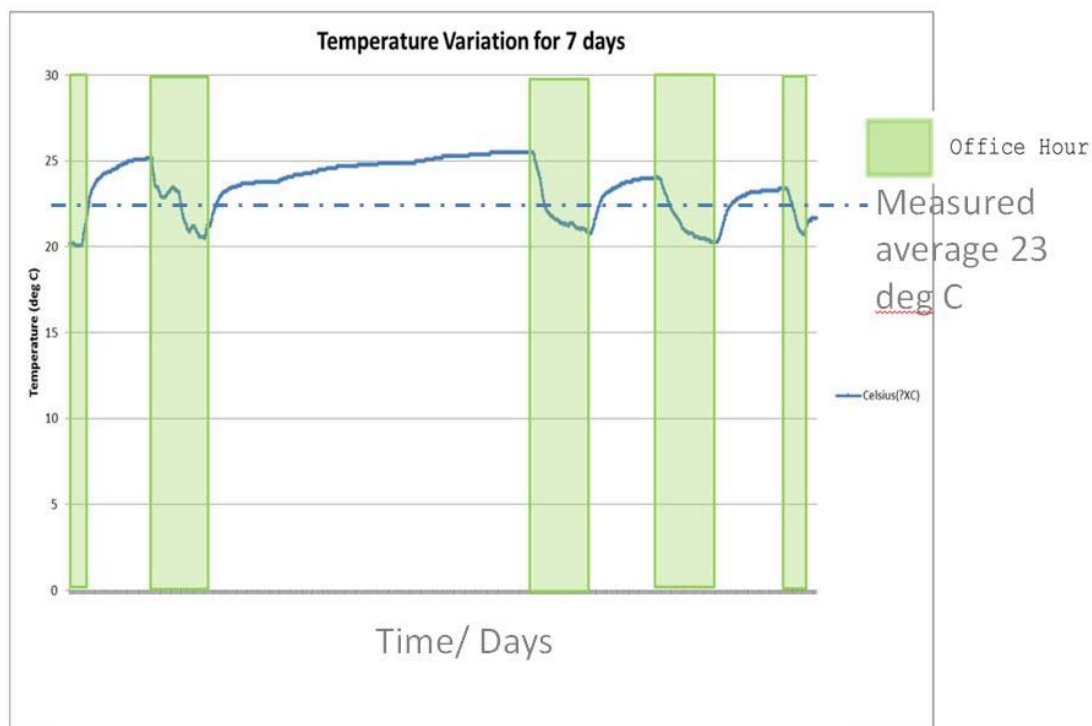

Fig 7a) Temperature variation graph of a typical office for 7 days

### Recommendation

It is recommended to adjust indoor air temperature by setting the thermostats at 24 deg C while the AHU supply air temperature remain unchanged, the AHU motor reduces its speed so as to reduce the flow rate of supply air. Thus, energy consumption of AHU can be reduced.

### Energy Saving Estimation:

#### Current Situation:

AHU supply air temperature: 15 deg C

Measured average return air temperature: 23 deg C

$$\Delta T_1 = 23 - 15 = 8 \text{ deg C}$$

#### Proposed Situation:

AHU supply air temperature: 15 deg C

Target return air temperature: 24 deg C

$$\Delta T_2 = 24 - 15 = 9 \text{ deg C}$$

According to ASHRAE Standard 90.1-2013 table G3.1.3.15, their part load performance characteristics shall be modeled as below.

Fan Part-Load Ratio	Fraction of Full-Load Power
0.00	0.00
0.10	0.03
0.20	0.07
0.30	0.13
0.40	0.21
0.50	0.3
0.60	0.41
0.70	0.54
0.80	0.68
0.90	0.83
1.00	1.00

where Fan Part-Load Ratio means ( Current Flow (L/s) / Rated Flow(L/s))

	Before RCx	After RCx
Measured Current Flow (L/s)	4450	3600
Fan Rated Flow (L/s)	4600	4600
Fan Part-Load Ratio	0.97	0.78
Fraction of Full Load Power	~0.95	~0.65

Measured electricity consumption of all AHUs in that measurement hour (before RCx)  
 = **590kW** - (1)

Calculated electricity consumption of all AHUs in an hour by adjusting indoor air temperature set point hence reduces the AHU flowrate:

Hourly Electricity Consumption:

= Adjusted power before RCx (rated load power) x Fraction of Full Load Power after RCx

$$= \frac{590}{0.95} \times 0.65 = \mathbf{404 \text{ kW}} - (2)$$

Assume the AHU operation from Monday to Friday, 8:00 to 18:00.

Numbers of hour that can adopt with similar cooling load in annual: 662 hours

➤ Calculated annual electricity saving of all AHUs after RCx:

$$= ((1) - (2)) \times 662 \text{ hours}$$

$$= (590 \text{ kWh} - 404 \text{ kWh}) \times 662 = 123,132 \text{ kWh} - (A)$$

➤ Measured annual electricity consumption saving of all AHUs before RCx:

$$= 1,348,950 \text{ kWh} - (B)$$

**Annual AHU electricity consumption saving is around (A) / (B) x 100% = 9%.**

### Example 8 - Air-conditioning (Air-side System)

#### Energy Saving Opportunity

To adjust operation hours of Primary Air Handling Units

#### Background Information

AHUs serving conditioned spaces start operating from 8:00 a.m. on Tuesday to Friday and from 7:30 a.m. on Monday for morning start pre-cooling.

#### Facility / Equipment: AHU / PAU

Air Handling Units (AHUs) and Primary Air Handling Units (PAUs)



#### Site Measurement, Observation and Findings

By checking the control logic, it was found that the PAUs are interlocked with the AHUs and operating with the same time schedule.

#### Recommendation

Delay morning start-up of the PAUs in order to reduce the cooling energy required for treating the outdoor air during pre-cooling period. As such, the control logic of PAUs can be modified so that PAUs will start only 15 minutes before the normal operating hour of the building.

### Energy Saving Estimation:

Assumptions:

- Potential saving of PAU fan power consumption 25kW;
- Potential saving from the chiller plant due to the reduction of cooling load from fresh air 120kW;
- Saving from operation of: -
  - Mon delay start for 1.25 hours
  - Tue to Fri delay start for 0.75 hours
  - Mon to Friday early stop for 0.5 hours

Annual electricity consumption saving

= (Potential saving) x (Hours saving from weekly operation) x No. of weeks

= 49,000kWh



## Example 9 - Air-conditioning (Air-side System)

Energy Saving Opportunity  
To review and adjust pressure setting for VAV systems

### Background Information:

Review and adjust pressure setting for VAV systems

### Facility / Equipment:

Air Handling Units (AHUs) and VAV boxes

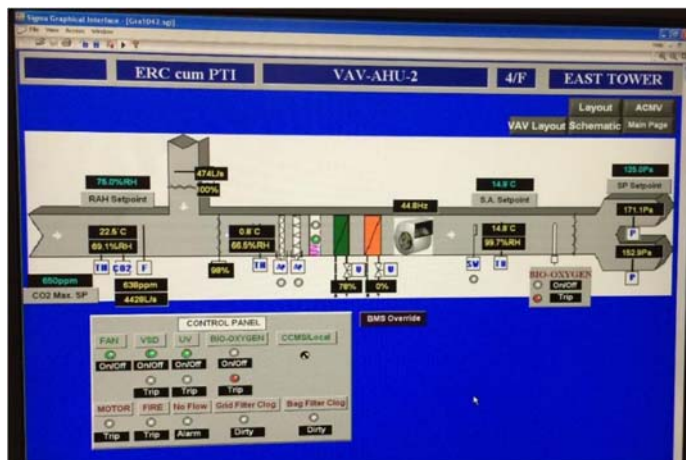

### Site Measurement, Observation and Findings

No reading on the air flow of some VAV boxes was found during RCx inspection and the position of air damper in such VAV box was always fully opened. The pressure sensors may be clogged or failed or setting deviated from the design pressure/flow value for the VAV box.

### Recommendation:

It is recommended to repair/replace faulty sensors and review the settings for VAV boxes so that conditioned air is supplied based on the actual demand. In addition, the amount of air supplied by AHUs of VAV system will also be reduced accordingly which resulted in a decrease in fan power and thus energy consumption of the VAV systems.

### Energy Saving Estimation:

Assumptions:

- Estimated fan power saving from air side equipment : 18KW
- Saving from operation of 8 hours per day from Mon to Fri

$$\begin{aligned} & \text{Annual electricity consumption saving} \\ & = (\text{Potential saving}) \times (\text{Hours saving from daily operation}) \times \text{No. of day} \times \text{No. of weeks} \\ & = \underline{\underline{36,000 \text{ kWh}}} \end{aligned}$$

### Example 10 - Air-conditioning (Water-side System)

**Energy Saving Opportunity:**  
To setback chilled water supply temperature during non-office hour operation

#### Background Information

In a building, there are 2 sets of air-cooled packaged screw type chillers (1 duty & 1 standby each with 300 kW cooling capacity) for the non-office hour operation. These two chillers served following areas: - FCUs of electrical switch rooms, PABX rooms, office areas and training rooms. The chilled water supply temperature of these chillers is designed and operated at deg 7.

Operation schedule of chiller is listed below:

Mon to Fri 00:00 to 07:00 & 21:00 to 24:00 (i.e. 50 hours)

Sat 00:00 to 07:00 & 17:00 to 24:00 (i.e. 14 hours)

Sun 00:00 to 24:00 (24 hours)

#### Facility / Equipment

Non-office hour chiller (300 kW)



#### Site Measurement, Observation and Findings

By checking the technical data of chiller performance, the amount of energy consumed by chiller can be reduced by setting a higher chilled water supply temperature during the non-office hour.

### Recommendation

It is proposed that building operator could raise the supply chilled water temperature during non-office operation. As such, the chilled water supply temperature delivered by the chiller would be about deg 9 which is deg 2 higher than the original operating condition.

### Energy Saving Estimation:

- One unit of chiller operating for the period;
- Chilled water temp. setback by deg 2;
- Operation of non-office chiller  
Mon to Fri 00:00 to 07:00 & 21:00 to 24:00  
Sat 00:00 to 07:00 & 17:00 to 24:00  
Sun 00:00 to 24:00
- 
- Estimated saving is about 6% on the average chiller power consumption

Annual electricity consumption saving

= (Potential saving) x (Hours saving from weekly operation) x No. of weeks

~ **8000kWh**

### Example 11 - Air-conditioning (Water-Side System)

**Energy Saving Opportunity:**  
To adjust the chilled water flowrate during non-office hours

#### **Background Information:**

Improve operation of water-side equipment by checking the temperature different between supply and return chilled water temperature.

#### **Facility / Equipment**

Equipment Involved: Chilled Water Pump (rated pump power 9 kW)



#### **Site Measurement, Observation and Findings**

A small temperature difference (2.7 deg C) was observed from the measurement result of supply and return chilled water temperature at chilled water system at night mode. The chilled water flowrate was measured at 20.7 l/s.

Based on a normal temperature difference of 5 deg C between supply and return chilled water temperature, the required chilled water flowrate is calculated at 11.5 l/s and the actual flowrate is nearly doubled of required chilled water flowrate.

#### **Recommendation:**

It is recommended to adjust the water flow delivered by the chilled water pump for non-office hours/period in order to reduce the chilled water flowrate and performance of the water side equipment can be improved.

### Energy Saving Estimation:

Assumptions:

- Pump Power reduced from 13.5kW to 8.0kW
- 
- Saving from operation of:
  - Mon to Fri 00:00 to 07:00 & 21:00 to 24:00
  - Sat 00:00 to 07:00 & 17:00 to 24:00
  - Sun 00:00 to 24:00 (24hours)

Annual electricity consumption saving

= (Potential saving) x (Hours saving from weekly operation) x No. of weeks

= 25,000kWh

### Example 12 – Electrical System

**Energy Saving Opportunity:**  
To review power quality of electrical distribution network

#### Background Information:

Electrical installation includes electrical distribution networks in the building from power source to final sub-circuit connected to electrical apparatus. Excessive distribution loss and poor power quality reduce efficiency of the electrical distribution network, cause unwanted energy losses, as well as overheating of conductors and apparatus that may impose additional cooling load for air-conditioning system. RCx would focus on power quality of electrical distribution network to identify potential ESOs.

In the course of RCx, RCx Team shall identify all available metering devices in the electrical distribution network and collect historic data. In case metering provision is not available, temporary or additional metering devices may be installed to facilitate evaluation of saving achieved by ESOs after Implementation. In long terms, it is good practice to install permanent metering provision and power monitoring system to keep track on energy performance of building.

#### Facility / Equipment :

Electrical distribution networks in the building

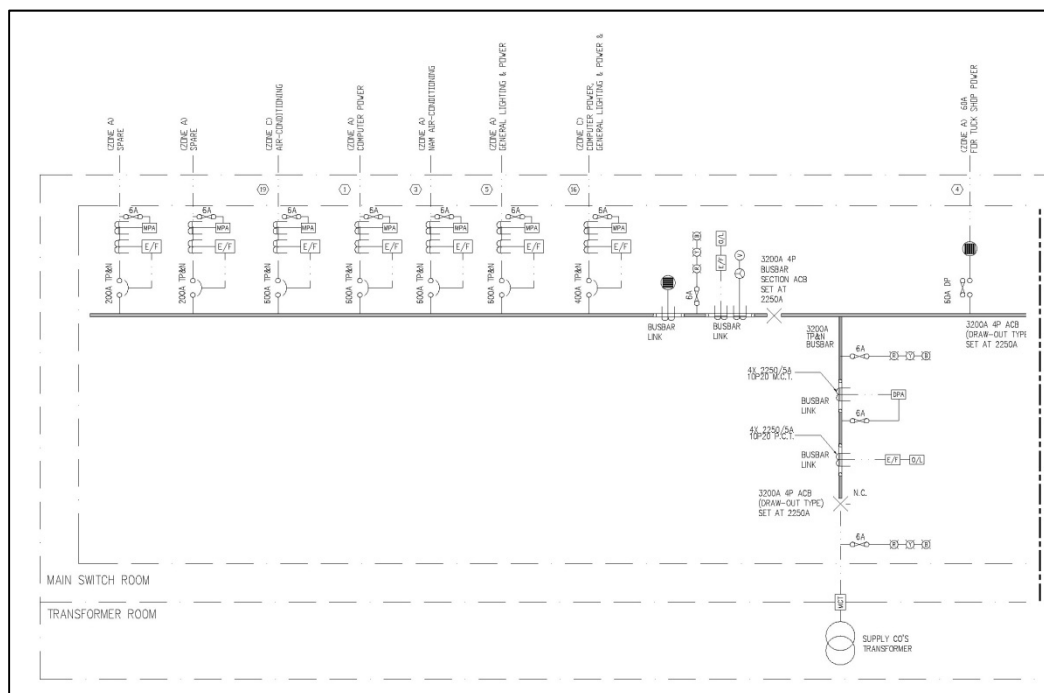

## Site Measurement, Observation and Findings

### 1. Total Power Factor (TPF)

A reactive load, such as an induction motor induces reactive power that adds to the current in the circuit, which does not doing productive work. The term power factor, a ratio ranging from 0 to 1, is used to describe the extent of the productive work of a load. The ratio is given by the real power doing productive work to that of the apparent power that performs both productive and non-productive work, a close to 1 power factor implying an energy efficient load.

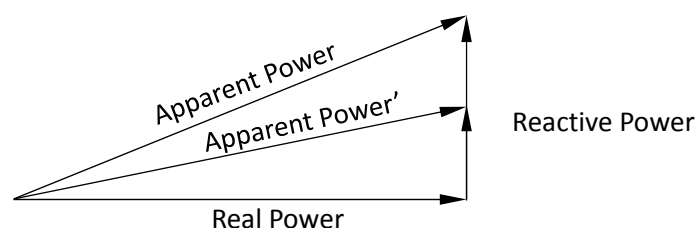

Figure 1: Power triangle for Apparent Power, Real Power and Reactive Power

(Note: Apparent Power' refers to the apparent power after power factor correction)

When TPF is lower than the minimum requirements of electricity suppliers, relevant correction device shall be provided. Beyond the minimum requirements, TPF can be further enhanced with appropriate size of correction device. The achievable energy saving by improving TPF of a circuit will be equal to the reduction of magnitude of the apparent power.

### 2. Total Harmonic Distortion (THD)

Harmonic currents, generated by non-linear loads (such as fluorescent lamp control gear, frequency inverter, personal computer etc.) installed in building, increase energy losses in the electrical distribution network. Harmonic currents also heat up conductors and apparatus that increase cooling demand of the air-conditioning system, as well as causing other harmful effects to the electrical distribution network.

Harmonic currents can impose significant impact on electrical distribution network and waste energy. Harmonic correction devices shall be provided when the %THD overs the specified limits. The lower the %THD, the lesser the power or energy wasted.



### 3. Measuring and Improving TPF and THD

If the measured TPF and THD fall in to unacceptable range, correction devices shall be provided with proper size according to the measurement results.



Photo 1: A metering device for a 400A circuit

In addition, identifying the size and location of reactive loads and non-linear loads should be an important part during Investigation for the electrical installation. It is much more effective to correct power factor and harmonic current close to the load that degrades power quality. Therefore, the RCx Team shall not limit the Investigation to main, sub-main and feeder circuits. Measurement of TPF and THD to downstream and final circuits shall be conducted as far as practicable. When a particular load or a group of loads (such as numbers frequency invertors) that led to a high level of power quality degradation is found, provision of correction device close to the load is preferable. On the other hands, group correction for TPF and THD is also acceptable for cost effectiveness consideration.

Improving power quality of electrical installation reduces energy wastage in the electrical circuit and minimize associated unwanted effects, such as heating up of conductors and tripping of protective devices. In term of energy cost, both energy charge (kWh) and demand charge (kVA) of the building can be reduced with better power quality.

### 4. Energy Saving Estimation

Enhancing power factor of electrical circuit reduces unwanted reactive current. The reactive current itself does not result in energy consumption. However, the reactive current increases copper loss of the electrical distribution network. The energy saving achieved by improving power factor is mainly contributed by reduction in copper loss. Such saving energy is generally in a low magnitude.

On the other hands, for building under electricity tariff scheme charging by both energy charge (kWh) and demand charge (kVA). Improving TPF of the building can directly reduce the demand charge by reducing the peak electricity demand value. This provides a much significant reduction in electricity cost of the building.

Energy saving form reducing copper loss:

Copper loss =  $I^2R$  &

Power Factor (PF) of a building/a circuit increases from 0.95 to 0.85 by installed and operated with appropriated power factor correction devices.

The loss fraction reduction through improving power factor is expressed by:

$$[1-(PF/PF')^2] \times 100\% \text{ (note 1)}$$

when:

PF = original power factor of a circuit without correction device

PF' = power factor of a electricity circuit operated with appropriated power factor correction device

As the PF improves from 0.85 to 0.95, the loss fraction reduction is:

$$[1-(0.85/0.95)^2] \times 100\% = 20\%$$

Assume the original copper loss of the circuit without correction device is about 2%, the reduced copper loss is 0.4% (= original copper loss (2%) x 20%). Thus, saving of 0.4% electricity consumption can be achieved when correction devices are operated with appropriated power factor correction devices at load side.

As the building with annual electricity bill of HKD 4,000,000, the energy charge and demand charge is about 85% and 15% of the electricity bill respectively.

When correction devices are operated with appropriated power factor correction devices, annual electricity cost saving due to reduction of copper loss is calculated below:

$$= \$ 4,000,000 \times 85\% \times 0.4\%$$

$$= \$ 13,600$$

Demand charge saving:

Reduction in peak demand can be calculated by:

$$(1 - \text{TPF} / \text{TPF}') \times 100\% \text{ (note2)}$$

when:

TPF = original TPF of the building

TPF' = TPF of the building after improving of TPF

Reduction in peak demand (kVA)

$$= (1 - 0.85/0.95) \times 100\% = 10.5\%$$

As demand charge accounted for 15% of the electricity bill, annual electricity cost saving

$$= \text{HKD } 4,000,000 \times 15\% \times 10.5\%$$

$$= \text{HKD } 63,000$$

The total saving

Improving TPF of the building can directly reduce annual electricity cost: -

$$= \$ 13,600 + 63,000$$

$$= \$ 76,600$$

## 5. Metering and Monitoring of Electrical Distribution Network

Electricity bill only provides overall electricity consumption of the building on monthly basis. Understanding the power quality and electricity consumption of each installations/component are important to analysis energy performance of a building.

Metering facilities and monitoring provisions will provide electricity consumption data and power quality data for analysis for evaluation of saving after implementation of ESOs and assists the building owner to manage energy performance of the building.

### Example 13 – Lighting System

Energy Saving Opportunity:  
To adjust lighting level

#### Background Information:

Check and review lighting level of different functional area.

#### Facility/Equipment:

Functional area with lighting installation

#### Site Measurement, Observation and Findings

- Use lux meter to check the lighting level of the area.
- Check the measurement result against current facility requirement and international standard.
- Estimate adjust the lighting layout and/or identify potential of de-lamping.

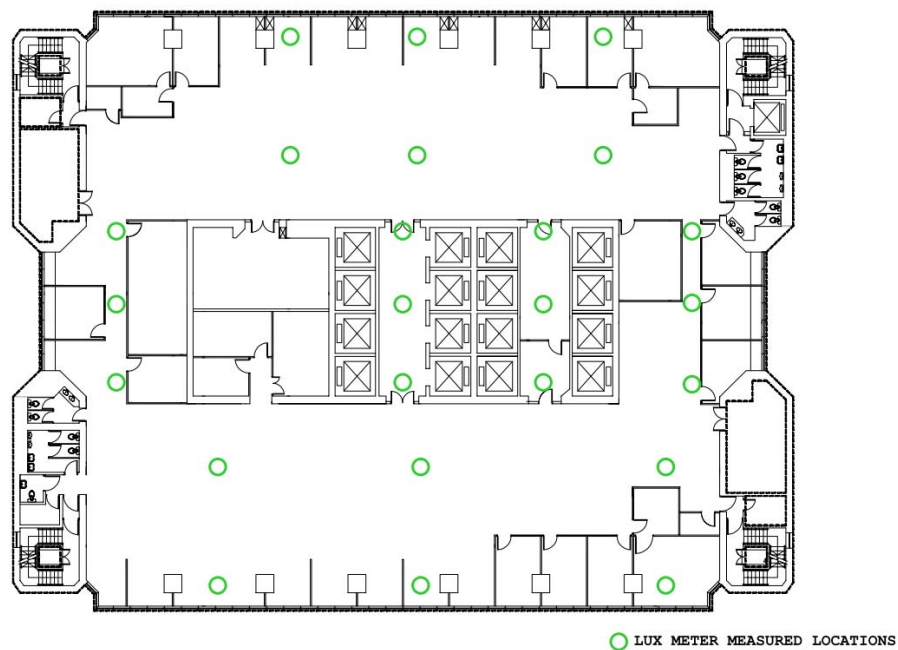

Fig 13a) Floor Plan of a typical office

### Energy Saving Estimation

Assume there are 30 T5 fluorescent luminaires in the office and 5 of them can be taken down.

N = total number of existing lamps

N' = total number of proposed lamps

P = power demand of each lamp (W)

D = daily operation hour (hr/day)

A = annual operation day (day)

Assume T5 1500 fluorescent luminaires = 35 W

$$\text{Annual Energy Saving (kWh)} = (N - N') * P * D * A$$

$$\begin{aligned} \text{Annual Energy Saving (kWh)} &= (275) * 35 * 8 * (240) \\ &= 18,480 \text{ Kwh} \end{aligned}$$

#### Example 14 – Others

**Energy Saving Opportunity:**  
To adjust equipment operational hour

#### **Background Information:**

Adjust operational hour of plant and equipment with timer control only, especially those did not connected with building management system.

#### **Facility / Equipment:**

Air handling unit, ventilation fan and/or lighting installation controlled by timer.

#### **Site Measurement, Observation and Findings**

- Use power meter / amp meter with logger to measure the daily operation of facility or equipment continuous for a period.
- It is recommend that the measurement period shall cover working day, weekly holiday and public holiday.
- Check the measurement result against the working hour of the building / functional area to fine tune the operational hour of facility or equipment.

#### **Energy Saving Estimation**

Saving = Equipment power rating × saved operation hour

Example 15 – Others

**Energy Saving Opportunity:**  
 To adjust combustion efficiency

**Background Information: -**

Adjust Fuel gas / air ratio in order to improve combustion efficiency of gas boiler.

**Facility / Equipment: Gas Boiler**

Gas Boiler for hot water supply to shower room and washrooms, heated swimming pool, kitchen and pantry etc.

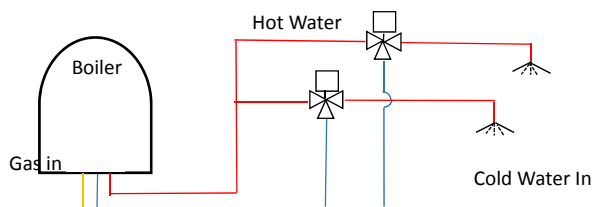

**Site Measurement, Observation and Findings**

- Measure Carbon Monoxide (CO) content of flue gas at boiler exhaust and trace amount of CO;
- Incomplete combustion may occur during the boiler operation if amount of CO content in flue gas is high;
- Adjust gas to air ratio in order to achieve better combustion efficiency such that the flue gas with maximum amount of CO<sub>2</sub> and minimum amount of CO.
- A theoretical combustion ratio can be reference to 'Figure I'.

**Energy Saving Estimation**

$$\% \text{ of CO (Produced from combustion)} = (\text{Measured CO in ppm} / \text{CO density in kg/m}^3) / 1000 - \% \text{ of CO (from Gas)}$$

$$\% \text{ excess fuel gas in combustion} = \% \text{ of CO (Produced from combustion)}$$

$$\text{Annual Fuel gas saving} = (\text{Annual consumption of fuel gas}) \times (\% \text{ excess fuel gas in combustion})$$

**Case Study**

The Boiler's annual gas consumption is about 18,195 unit and spending about \$221,311 for the bill per annual.

According to the site measurement, the measured concentration of CO is 78 ppm.

$$\begin{aligned} \% \text{ of CO (Produced from combustion)} &= (78 / 1.4^{*1}) / 1000 - 2.1\%^{*2} \\ &= 5.3\% - 2.1\% \\ &= 3.2\% \end{aligned}$$

$$\% \text{ excess fuel gas in combustion} = 3.2\%$$

$$\text{Annual Fuel gas saving} = (\text{Annual gas consumption}) \times (\% \text{ excess fuel gas in combustion})$$

$$\begin{aligned} \text{Annual Fuel gas saving} &= 18,195 \times 3.2\% \\ &= 582 \text{ unit} \\ &= 27,936 \text{ MJ}^{*3} \\ &\sim \$ 7,000 \end{aligned}$$

Remark:-

\*1 CO density in kg/m<sup>3</sup> = 1.14kg/m<sup>3</sup>

\*2 In the study, the concentration of CO in fuel gas is ranged from 1% to 3.1%. The average value of CO concentration is 2.1%.

\*3 Each unit of fuel gas represents a heat value of 48MJ

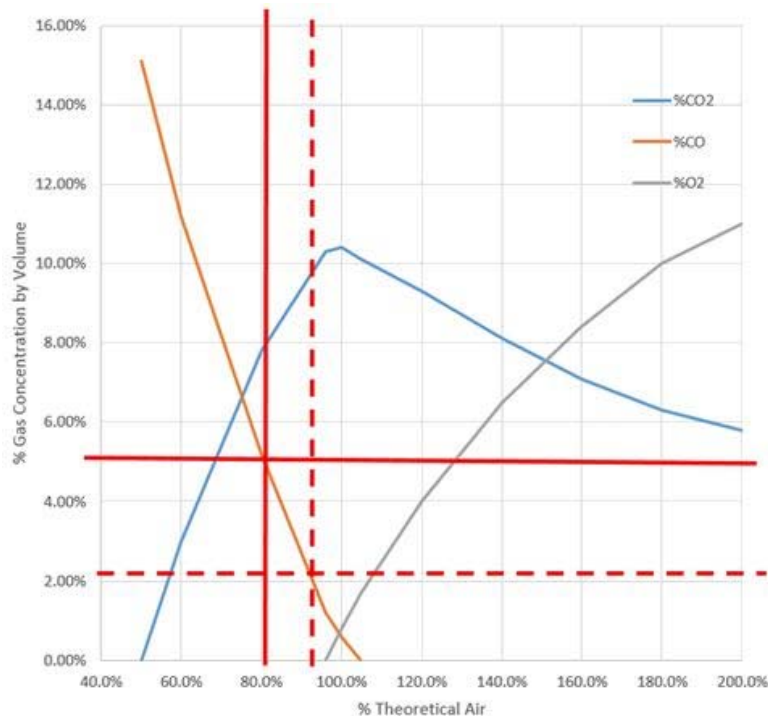

Figure I – Theoretical Combustion



### Example 16 – Others (By Computer Simulation)

#### Energy Saving Opportunity:

To adopt the use of daylighting (by computer simulation)

#### Background Information: -

Electrical lighting can be a major source of energy consumption for an office building. For an example building, lighting energy accounts for almost 20% of overall electrical consumption. At present, no daylighting sensors are installed in the building except for the main entrance lobby. As a consequence, lighting fixtures keep on operating even when a space is well illuminated due to transmission of visible light during daytime.

#### Facility / Equipment: Gas Boiler

Lighting in Carpark Area



#### Site Measurement, Observation and Findings

- (1) Collect trend logged data

There are no sub-meters to monitor and trend log the lighting power consumption for each floor. The lighting is controlled according to pre-set operating schedules as below.

Location	Operation schedule
Office Area, Canteen, Mess Canteen, Lift Lobby, Toilet, Carpark	24 hours
Landscape Area	18:15 - 6:15 (Mon - Sun)
Corridor	06:00 - 24:00 (Mon - Fri)
Fitness Room	08:00 - 24:00 (Mon - Sun)

*Table 1 Example of Lighting operating schedule*

(2) Analyse the collected trend logged data by simulation

The operating schedules were entered into the 3D simulation model together with the light fitting numbers and lamp type to simulate the light operation in real life. The simulated lighting power consumption per month is shown below.

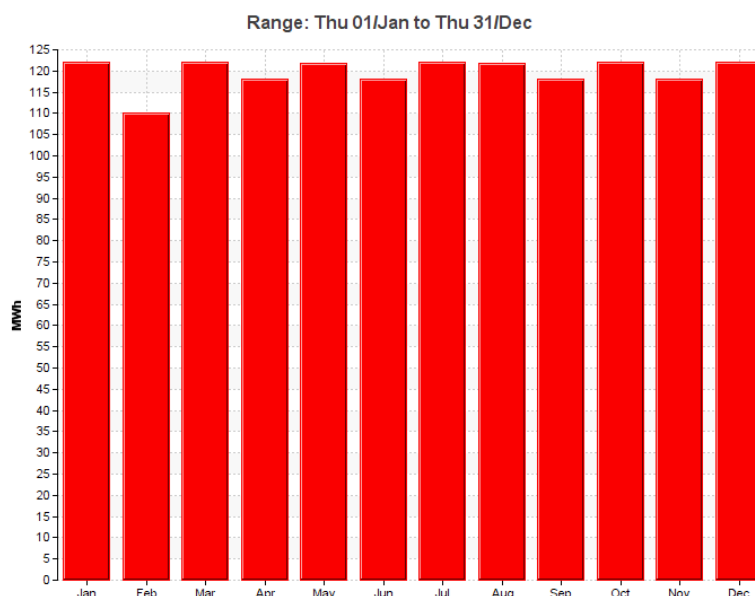

*Figure 1 Example of simulated lighting monthly power consumption*

(3) Identify Energy Saving Opportunities (ESOs)

It is proposed to install daylighting sensors in all of the perimeter spaces and the parking area that receives direct solar radiation during the daytime. These daylight sensors will perceive the illuminance level inside a space and turn off the electrical lighting when the lux level inside the space exceeds the permissible limit. In this way, both lighting energy as well as energy consumed for space cooling of the space can be saved. The permissible lux level recommended for the applicable spaces are given below:

Space Type	Typical illuminance level (lux)
Offices	300-500*
Parking	50**
Corridor	100***
Dinning	200***
Changing room	200***

\* CIBSE (Chartered Institute of Building Services Engineers) Lighting Guide 07: Offices (2005)

\*\* Labor Department HKSAR Guidelines for Good Occupational Hygiene Practice in a Workplace (2011).

\*\*\* British Standard BSEN 12464-1:2011 Light and lighting – Lighting of work places

*Table 2 Example of illuminance level for lighting control switch*

#### (4) Principal

Daylight sensors are connected to the electrical lighting switch, when sufficient illuminance level is detected at the sensors location, an electrical signal will be sent to the lighting switch to turn off the lighting automatically.

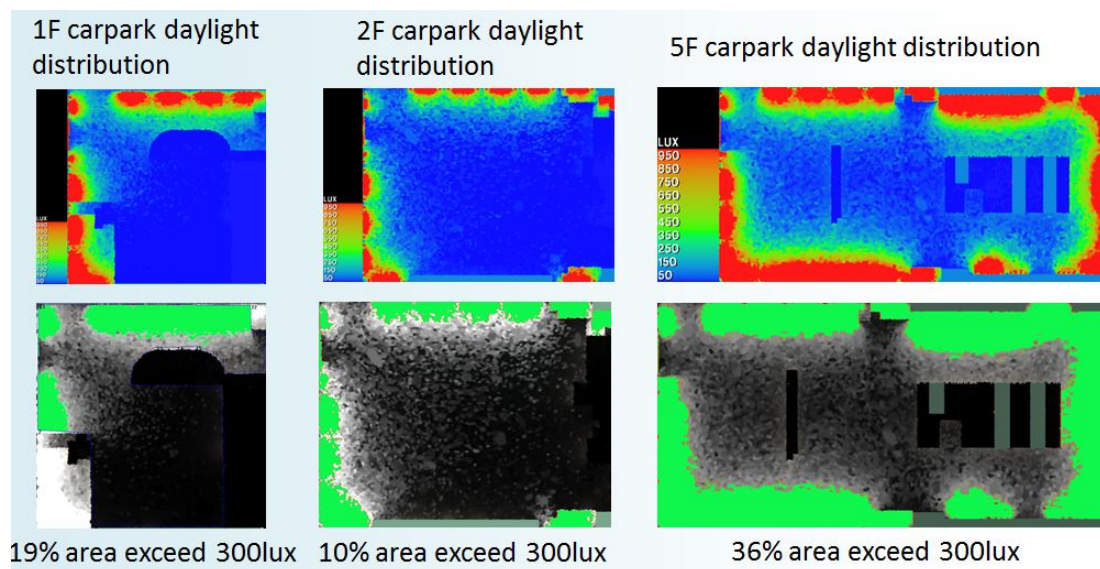

#### Energy Saving Estimation

The estimated energy savings (kWh) is around 1-3% on lighting power consumption.

Example 17 – Others(By Computer Simulation)

**Energy Saving Opportunity:**

To improve the chiller plant performance by resetting the condensate water temperature (by computer simulation)

**Background Information: -**

There are two heat recovery VSD centrifugal chillers and two VSD centrifugal chillers all with ~1900kW cooling capacity installed. There are also one small screw chiller (~800kW) and one small air cooled chiller (~500kW) mainly to serve low load condition.

The operation control of the chillers is based on the building load demand (ranged from 300kW to 3500kW) and the operating hours of the chillers. According to data and description of on-site maintenance staffs, one to two large chillers will be sufficient to fulfil the building load demand throughout the year. With the small screw chiller used to serve the building during night time.

The chiller are linked with one set of chilled water pump and condenser water pump. There are four cooling towers in condenser water loop. According to data and description of on-site maintenance staffs, a maximum of two cooling towers will be sufficient to provide heat rejection throughout the whole year.

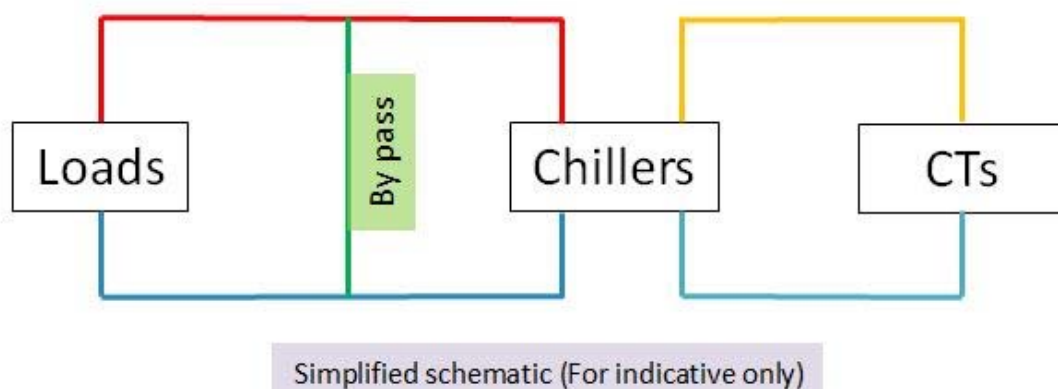

### Facility / Equipment:

Chillers, Chiller pumps, Cooling Towers, Condensate Water Pumps



### Site Measurement, Observation and Findings

The BMS does not have the capability for trend logging at the moment, five days of data has been extracted manually on-site for some quick investigation. The data that has been extracted including the followings:

- Chilled water flow rate
- Chilled water temperature differential
- Condenser water flow rate
- Condenser water temperature differential
- Cooling towers, condenser water and chilled water pumps power consumption
- Chiller power input

- (1) Analyse the collected trend logged data

Due to limited real life data availability, a 3D simulation model is used to reflect the operation of the building as closely as possible. For chiller plant adjustment, the following analysis has been carried out.

- Building cooling load profile analysis.
- Chiller part load performance curve analysis.
- Variation of condenser water temperature.
- Sequencing adjustment.
- Multiple cooling towers configuration.

The example building operates 24 hours for most floors, the cooling load demand ranged from 300kW to 3500kW. The profile is shown below.

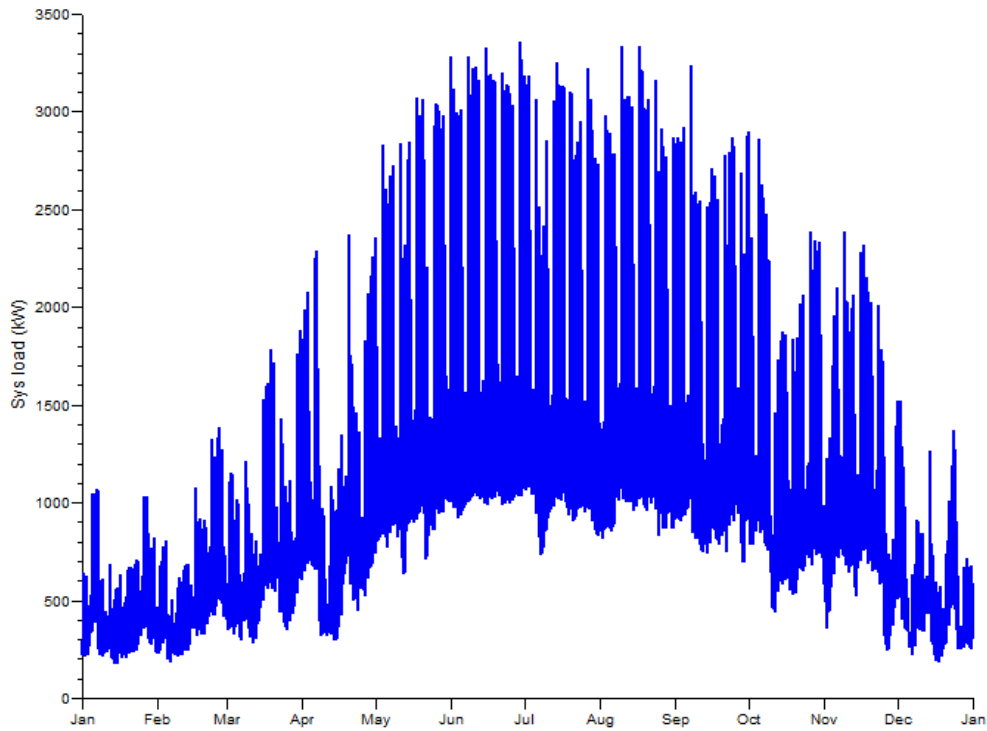

Figure 2 Example of a building cooling load profile

The monthly cooling load demand is shown below.

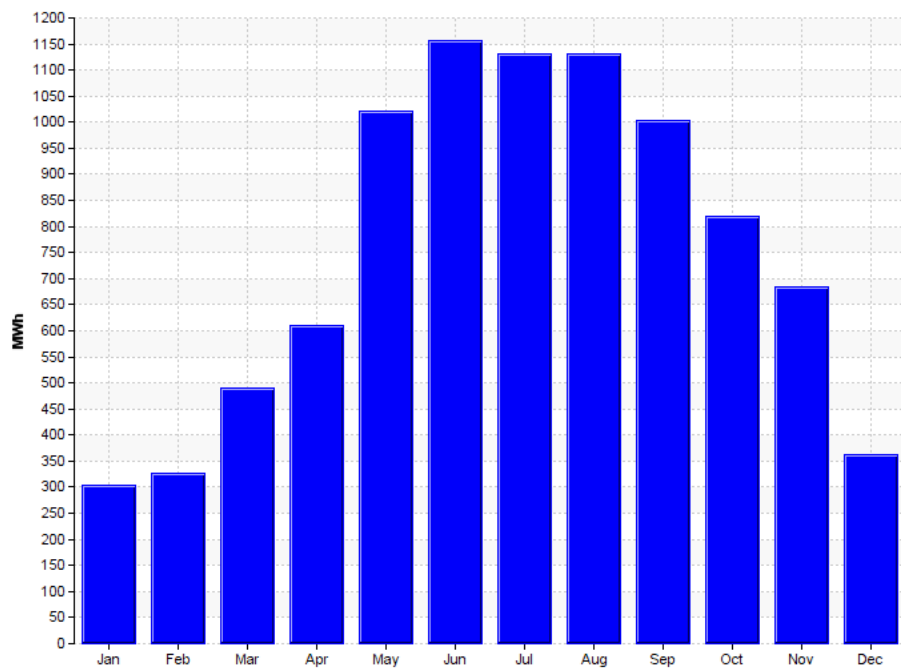

Figure3 Example of a building monthly cooling load

(2) Identify Energy Saving Opportunities (ESOs)

Condenser water temperature control

Condenser water entering temperature is currently uncontrolled and simply depends on external weather conditions. There is an opportunity for energy saving by further lowering the condenser water temperature during winter and spring period when the outdoor wet bulb temperature is low.

The target is to achieve an approach temperature of deg 2 to 6, this will allow the chiller to operate at higher efficiency without pushing the limit of the cooling towers.

The external wet bulb temperature for 2015 is shown below.

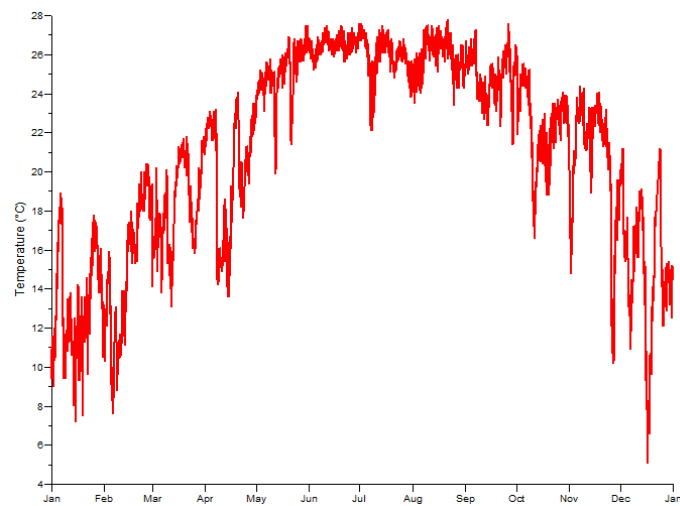

*Figure 4 Example of external wet bulb temperature*

The following graph compare the approach temperature (blue line) and the target condenser water entering temperature (red line).

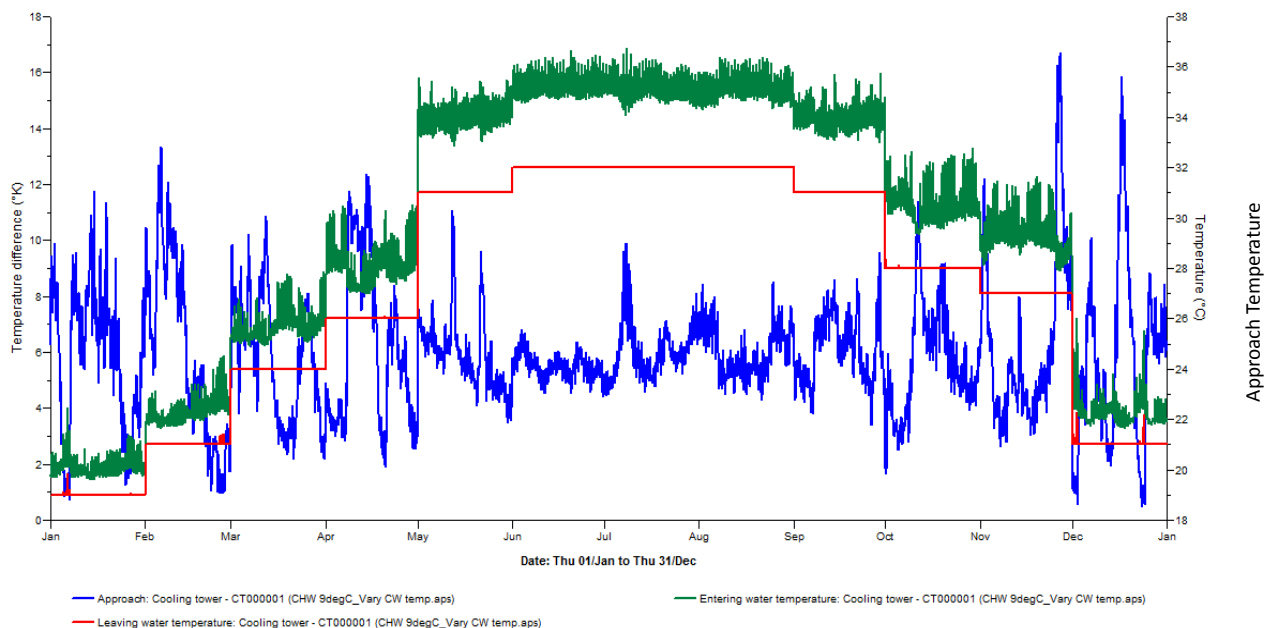
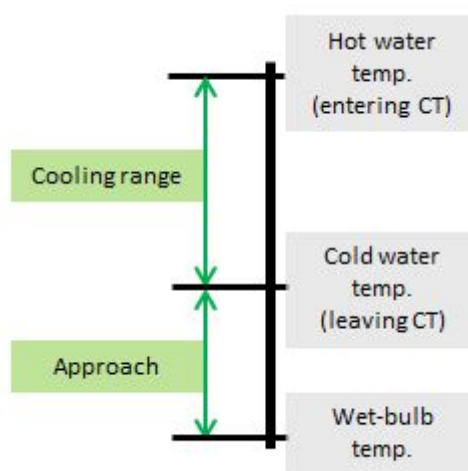

Figure 5 Example of condenser water temperature and approach temperature



- ✧ The *Approach Temperature* is the difference in temperature between the cooled water temperature and the entering air wet bulb temperature
- ✧

#### Cooling tower configuration

In order to maximize the effect of the Variable Speed Drive (VSD) in the cooling towers, it is proposed to operate two cooling towers even when only one chiller is operating (N+1 arrangement); by doing so the cooling towers fans will run at low speed increasing efficiency and reducing the fan power consumption.



(3) Principal

Depending on the external wet bulb temperature, it is recommended to consider adjusting the condenser water entering temperature accordingly to maximize the efficiency of the chiller.

Based on the characteristic of VSD fan in the cooling towers, it is recommended to consider running the cooling tower fans at lower fan speed. This can be achieved by running multiple cooling towers even during low load condition.

Chiller sequencing

The cooling load range distribution for each month is estimated as follow.

The graph show how frequent each cooling load range happen during the month.

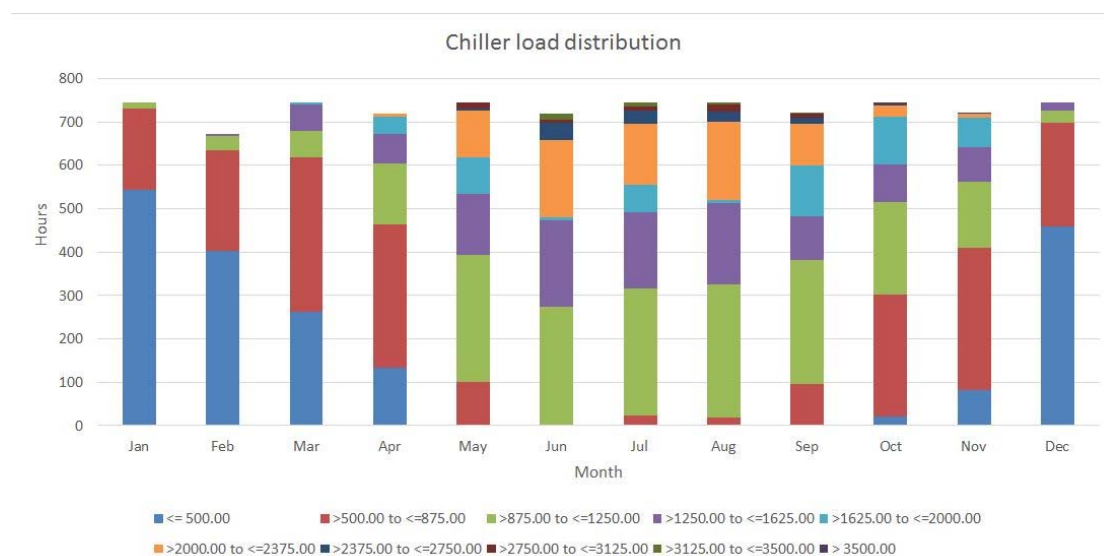

Figure 6 Monthly cooling load range (% hrs)

The graph above is used to analyse the opportunity for different chiller sequencing mode. This will need to be analysed in conjunction with the chiller part load performance graph (Figure 7) for better understanding of how to operate the chiller at its most efficient condition.

(Figure 7) for better understanding of how to operate the chiller at its most efficient condition.

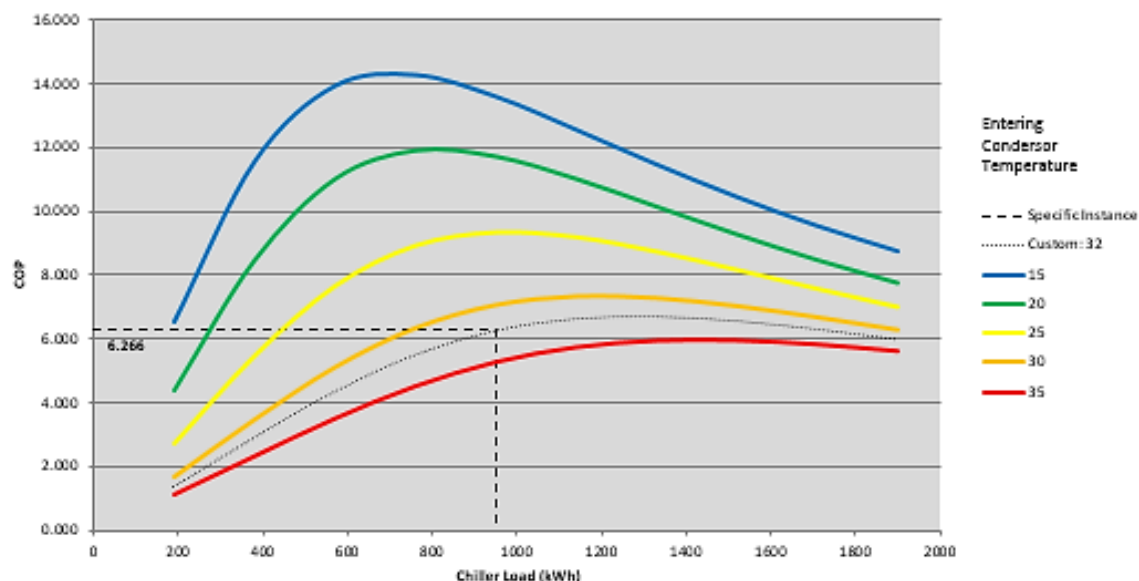

Figure 7 Generic VSD chiller performance curve

From the chiller curve above, it is noticed that the optimised chiller load range in different seasons will be as follow.

Season period	Condenser water temperature (°C)	Optimal cooling load range (kW)
Spring (March to May)	24 – 29	900 – 1200
Summer (June to August)	31	1200 – 1400
Autumn (September to November)	28 - 30	1100 – 1200
Winter (December to February)	20 - 22	750 – 900

Cooling load range

It is proposed to run one large VSD chiller during low load condition (up to 1700kW), two large VSD chillers at medium load conditions (1700kW – 3000kW) and three large VSD chillers at high load conditions (3000kW and above).

In order to utilize the benefit of VSD chiller high efficiency characteristic at low load condition. It is proposed to use the two VSD WCCs and two VSD HRCs to provide cooling to the building in the future even at low load condition. WCC1 and ACC should act as standby chillers only.

Operation Mode	Building load	No. of chiller required	Chiller to operate	No of cooling tower to operate
A	< 500kW	1	WCC1	2
B	500kW < and < 1700kW	1	HRC1/HRC2/WCC2/WCC3	2
C	1700kW < and < 3000kW	2	HRC1/HRC2/WCC2/WCC3 and HRC1/HRC2/WCC2/WCC3	3
D	> 3000kW	3	HRC1/HRC2/WCC2/WCC3 and HRC1/HRC2/WCC2/WCC3 and HRC1/HRC2/WCC2/WCC3	4

*Chillers operation modes schedule*

	Loading range	Suggested operation mode	Loading range	Suggested operation mode	Loading range	Suggested operation mode	Remarks
January	< 500kW	A	500kW < and < 1700kW	B	> 1700kW	B	Note 1
February	< 500kW	A	500kW < and < 1700kW	B	> 1700kW	B	Note 1
March	< 500kW	A	500kW < and < 1700kW	B	> 1700kW	B	Note 1
April	< 500kW	A	500kW < and < 1700kW	B	> 1700kW	B	Note 1
May	500kW < and < 1700kW	B	1700kW < and < 3000kW	C	> 3000kW	C	-
June	500kW < and < 1700kW	B	1700kW < and < 3000kW	C	> 3000kW	C	-
July	500kW < and < 1700kW	B	1700kW < and < 3000kW	C	> 3000kW	D	-
August	500kW < and < 1700kW	B	1700kW < and < 3000kW	C	> 3000kW	D	-
September	500kW < and < 1700kW	B	1700kW < and < 3000kW	C	> 3000kW	D	-
October	< 500kW	A	500kW < and < 1700kW	B	> 1700kW	B	Note 1
November	< 500kW	A	500kW < and < 1700kW	B	> 1700kW	B	Note 1
December	< 500kW	A	500kW < and < 1700kW	B	> 1700kW	B	Note 1

Notes

1. If loading more than 1 chiller capacity, extra chiller to be kick in

*Chillers monthly operation modes schedule*

For example, May month, it is estimated that the building load will range around 2000-2800kW during daytime and 600-1000kW during night time. Therefore it is proposed to operate two VSD chillers during the day and one VSD chiller at night throughout the implementation stage.

**Energy Saving Estimation:**

The estimated energy savings (kWh) is around 5%-10% overall on chiller system.

Supplementary Information  
Forms for Stage 1 to Stage 4

**Form 1.1 - Building Design and Operational Information Checklist**

(A)	General Building Attributes	
	Type of Building	
	Building Plans	<input type="checkbox"/> Yes <input type="checkbox"/> No
	Occupancy Schedule	<input type="checkbox"/> Yes <input type="checkbox"/> No
	Gross Floor Area (m <sup>2</sup> )	
	OP Certified Date (DD/MM/YY)	
	Recent Major Renovation (DD/MM/YY)	
	Contact Person for Information Collection	
(B)	Building Services System Information	
	<u>As- fitted BS Drawings (Schematic Diagrams and Services Layout Plans)</u>	
	- Air-conditioning System	<input type="checkbox"/> Yes <input type="checkbox"/> No
	- Electrical System	<input type="checkbox"/> Yes <input type="checkbox"/> No
	- Lighting System	<input type="checkbox"/> Yes <input type="checkbox"/> No
	- Plumbing System	<input type="checkbox"/> Yes <input type="checkbox"/> No
	- Lift and Escalator	<input type="checkbox"/> Yes <input type="checkbox"/> No
	<u>AA&amp;I Work (Schematic Diagrams and Services Layout Plans)</u>	
	- Air-conditioning System	<input type="checkbox"/> Yes <input type="checkbox"/> No
	- Electrical System	<input type="checkbox"/> Yes <input type="checkbox"/> No
	- Lighting System	<input type="checkbox"/> Yes <input type="checkbox"/> No
	- Plumbing System	<input type="checkbox"/> Yes <input type="checkbox"/> No
	- Lift and Escalator	<input type="checkbox"/> Yes <input type="checkbox"/> No

Technical Guidelines on Retro - commissioning

	<p><u>Air-conditioning System</u></p> <ul style="list-style-type: none"> <li>- Air-cooled Chiller</li> <li>- Water-cooled Chiller</li> <li>- Chilled Water Pump</li> <li>- Cooling Tower</li> <li>- Condenser Water Pump</li> <li>- Sea Water Pump</li> <li>- VRV System</li> <li>- Split-type System</li> </ul>	<p>Equipment Info: <input type="checkbox"/>Yes <input type="checkbox"/>No          Catalogue: <input type="checkbox"/>Yes <input type="checkbox"/>No          Equipment Info: <input type="checkbox"/>Yes <input type="checkbox"/>No          Catalogue: <input type="checkbox"/>Yes <input type="checkbox"/>No          Equipment Info: <input type="checkbox"/>Yes <input type="checkbox"/>No          Catalogue: <input type="checkbox"/>Yes <input type="checkbox"/>No          Equipment Info: <input type="checkbox"/>Yes <input type="checkbox"/>No          Catalogue: <input type="checkbox"/>Yes <input type="checkbox"/>No          Equipment Info: <input type="checkbox"/>Yes <input type="checkbox"/>No          Catalogue: <input type="checkbox"/>Yes <input type="checkbox"/>No          Equipment Info: <input type="checkbox"/>Yes <input type="checkbox"/>No          Catalogue: <input type="checkbox"/>Yes <input type="checkbox"/>No          Equipment Info: <input type="checkbox"/>Yes <input type="checkbox"/>No          Catalogue: <input type="checkbox"/>Yes <input type="checkbox"/>No</p>
	<ul style="list-style-type: none"> <li>- PAU /AHU</li> <li>- Other AC Equipment</li> </ul>	<p>Equipment Info: <input type="checkbox"/>Yes <input type="checkbox"/>No          Catalogue: <input type="checkbox"/>Yes <input type="checkbox"/>No          Equipment Info: <input type="checkbox"/>Yes <input type="checkbox"/>No          Catalogue: <input type="checkbox"/>Yes <input type="checkbox"/>No</p>
	<p><u>Lighting System</u></p> <ul style="list-style-type: none"> <li>- Lighting Fitting Schedule</li> <li>- Lighting Operation Schedule</li> <li>- Lighting Control Devices</li> </ul>	<p><input type="checkbox"/>Yes <input type="checkbox"/>No  <input type="checkbox"/>Yes <input type="checkbox"/>No          Equipment Info: <input type="checkbox"/>Yes <input type="checkbox"/>No          Catalogue: <input type="checkbox"/>Yes <input type="checkbox"/>No</p>

Technical Guidelines on Retro - commissioning

	<p><u>Lift and Escalator System</u></p> <ul style="list-style-type: none"> <li>- Passenger Lift</li> <li>- Goods Lift</li> <li>- Escalator</li> </ul>	<p>Equipment Info: <input type="checkbox"/>Yes <input type="checkbox"/>No          Catalogue: <input type="checkbox"/>Yes <input type="checkbox"/>No          Equipment Info: <input type="checkbox"/>Yes <input type="checkbox"/>No          Catalogue: <input type="checkbox"/>Yes <input type="checkbox"/>No          Equipment Info: <input type="checkbox"/>Yes <input type="checkbox"/>No          Catalogue: <input type="checkbox"/>Yes <input type="checkbox"/>No</p>
	<p><u>Plumbing System</u></p> <ul style="list-style-type: none"> <li>- Water Pump</li> </ul>	<p>Equipment Info: <input type="checkbox"/>Yes <input type="checkbox"/>No          Catalogue: <input type="checkbox"/>Yes <input type="checkbox"/>No</p>
	<p><u>Electrical System</u></p> <ul style="list-style-type: none"> <li>- Metering</li> <li>- Total Harmonic Distortion and Power Factor Correction Devices Installed</li> <li>- Variable Speed Drives Installed</li> </ul>	<p>Equipment Info: <input type="checkbox"/>Yes <input type="checkbox"/>No          Catalogue: <input type="checkbox"/>Yes <input type="checkbox"/>No    <input type="checkbox"/>Yes <input type="checkbox"/>No    <input type="checkbox"/>Yes <input type="checkbox"/>No</p>
	<p><u>General</u></p> <p>Equipment Operating Schedule</p> <p>Trend Log Data for Chillers / Pumps / PAU / AHU / etc</p> <p>T &amp;C Records</p> <p>Routine Maintenance Records for Last 36 Months</p> <p>O&amp;M Manuals</p> <p>Electricity Bill for Last 36 Months</p> <p>Gas Consumption Bill for Last 36 Months</p>	<p><input type="checkbox"/>Yes <input type="checkbox"/>No  <input type="checkbox"/>Yes <input type="checkbox"/>No  <input type="checkbox"/>Yes <input type="checkbox"/>No          (If No, please specify: _____)  <input type="checkbox"/>Yes <input type="checkbox"/>No          (If No, please specify: _____)  <input type="checkbox"/>Yes <input type="checkbox"/>No  <input type="checkbox"/>Yes <input type="checkbox"/>No          (If No, please specify: _____)  <input type="checkbox"/>Yes <input type="checkbox"/>No          (If No, please specify: _____)</p>

Technical Guidelines on Retro - commissioning

	BMS Data for at least 3 Months  Recent Energy Audit Report  IAQ Certification	<input type="checkbox"/> Yes <input type="checkbox"/> No (If No, please specify:_____)  <input type="checkbox"/> Yes <input type="checkbox"/> No  <input type="checkbox"/> Yes <input type="checkbox"/> No (If Yes, please specify Class:_____)
--	---	---

Remarks: Please amend the form to suit individual case



Form 1.2 – Current Facilities Requirements Form

Floor	Floor Description	Air Conditioning Provision		MV Provision		Lux Level	Area Operating Schedule for Occupancy
		Temperature (°C)	Humidity (%)	Fresh Air Intake Rate (L/s)	Exhaust Rate (L/s)		
		Current User Requirement	Current User Requirement	Current User Requirement	Current User Requirement		
							(Weekday): (Sat): (Sun):
							(Weekday): (Sat): (Sun):
							(Weekday): (Sat): (Sun):
							(Weekday): (Sat): (Sun):

Remarks: Please amend the form to suit individual case

Form 1.3 – Building Walk-Through Checklist

**Site Walk Through Checklist**

Central Chiller Plant

Water-cooled / Air-cooled Chiller / Heat Pump

Equipment No. (Year Installed)	Location	Installed Capacity (Ton)	Chilled Water Temp. (deg C) Supply Return	Flow Rate (L/s)	Evaporator Pressure (kPa)	Condenser Pressure (kPa)	Rated Power (kW)	Brand	Model No.	Type of Drive (e.g.CSD/VSD)

Site Photo Record for Equipment

Any Visual Inspected Defects:

**Site Walk Through Checklist**

Chilled Water Pumps

Equipment No. (Year Installed)	Location	Flow Rate (L/s)	Rated Power (kW)	Brand	Model No.	Type of Drive (e.g.CSD/VSD)

Site Photo Record for Equipment

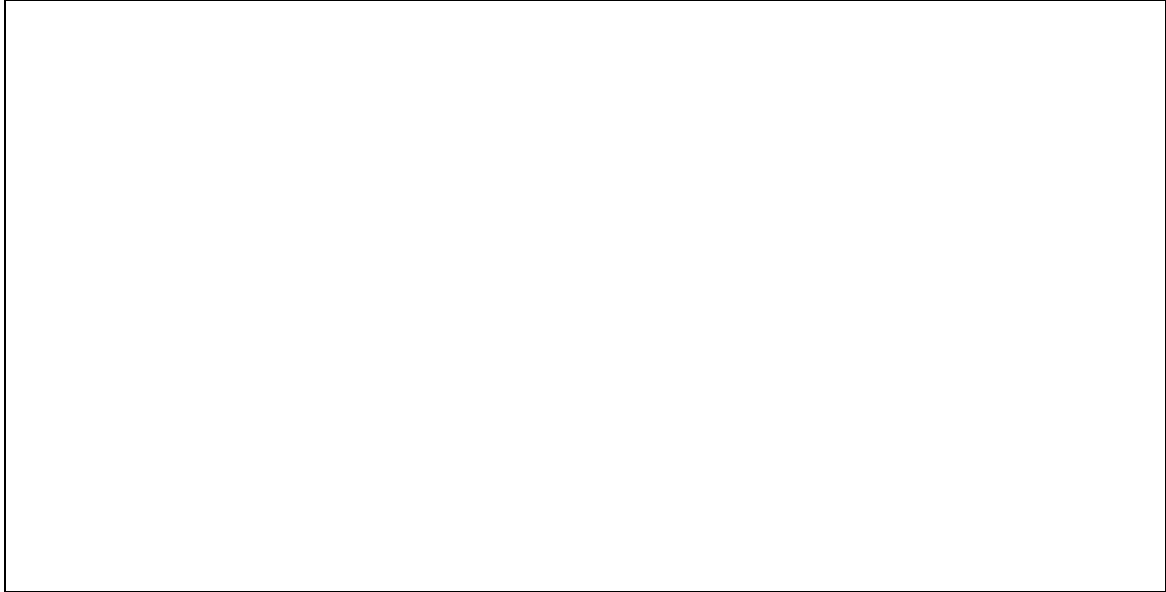

Any Visual Inspected Defects:



**Site Walk Through Checklist**

Heat Rejection Plant

Heat Rejection Equipment

Equipment No. (Year Installed)	Location	Type (e.g. Cooling Tower / Indirect Sea Water Cool / Direct Sea Water Cool)	Heat Rejection Rate (kW)	Brand	Model No.

Site Photo Record for Equipment

Any Visual Inspected Defects:

**Site Walk Through Checklist**

Condensing Water Pumps

Equipment No. (Year Installed)	Location	Flow Rate (L/s)	Rated Power (kW)	Brand	Model No.	Type of Drive (e.g.CSD/VSD)

Site Photo Record for Equipment

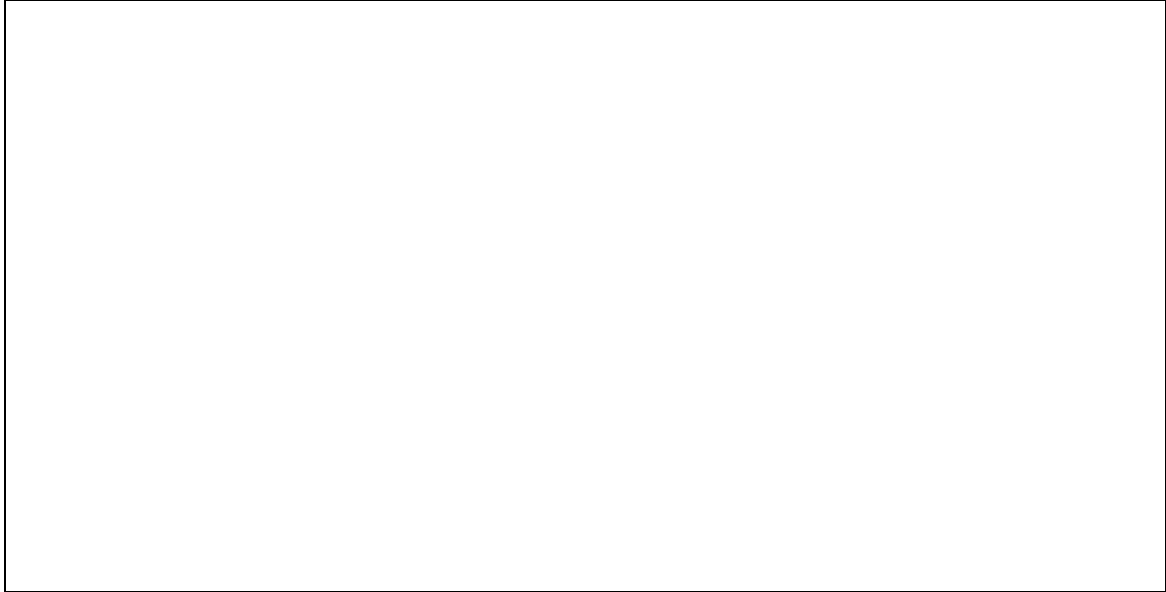

Any Visual Inspected Defects:



**Site Walk Through Checklist**

Central Hot Water Plant

Central Hot Water Equipment

Equipment No. (Year Installed)	Location	Type (e.g.Boiler)	Rated Power (kW)	Brand	Model No.

Site Photo Record for Equipment

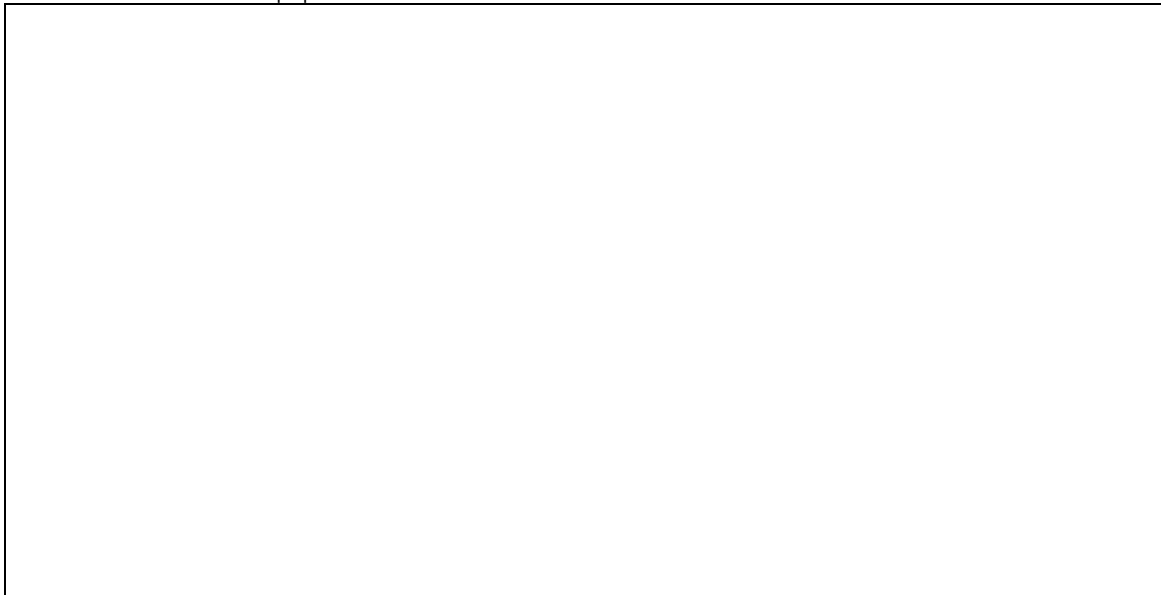

Any Visual Inspected Defects:



**Site Walk Through Checklist**

Hot Water Pumps

Equipment No. (Year Installed)	Location	Flow Rate (L/s)	Rated Power (kW)	Brand	Model No.	Type of Drive (e.g.CSD/VSD)

Site Photo Record for Equipment

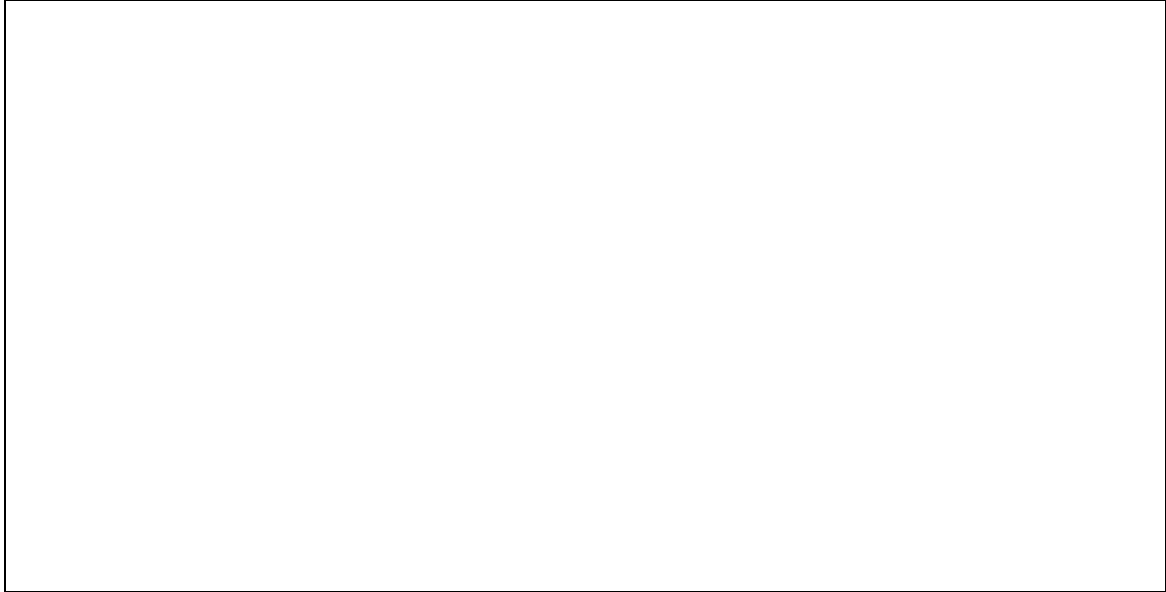

Any Visual Inspected Defects:



**Site Walk Through Checklist**

PAU / AHU

Equipment No. (Year Installed)	Location	Flow Rate (L/s)	Rated Power (kW)	Brand	Model No.

Site Photo Record for Equipment

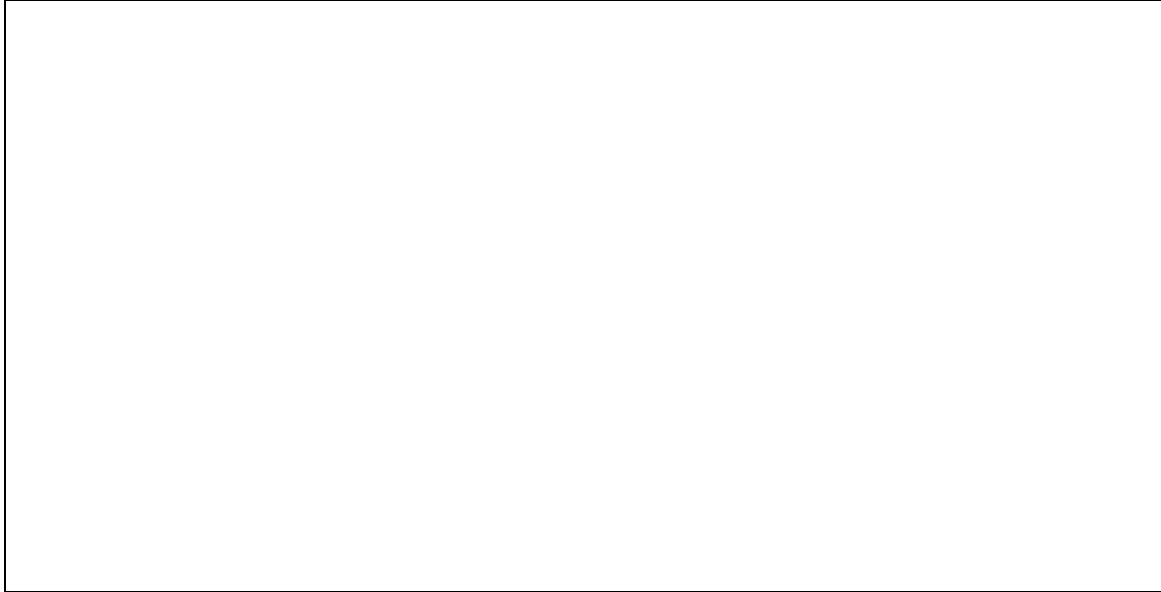

Any Visual Inspected Defects:





**Site Walk Through Checklist**

VRV / Split Type AC

Equipment No. (Year Installed)	Location	Installed Cooling Capacity (kW)	Rated Power (kW)	Brand	Model No.

Site Photo Record for Equipment

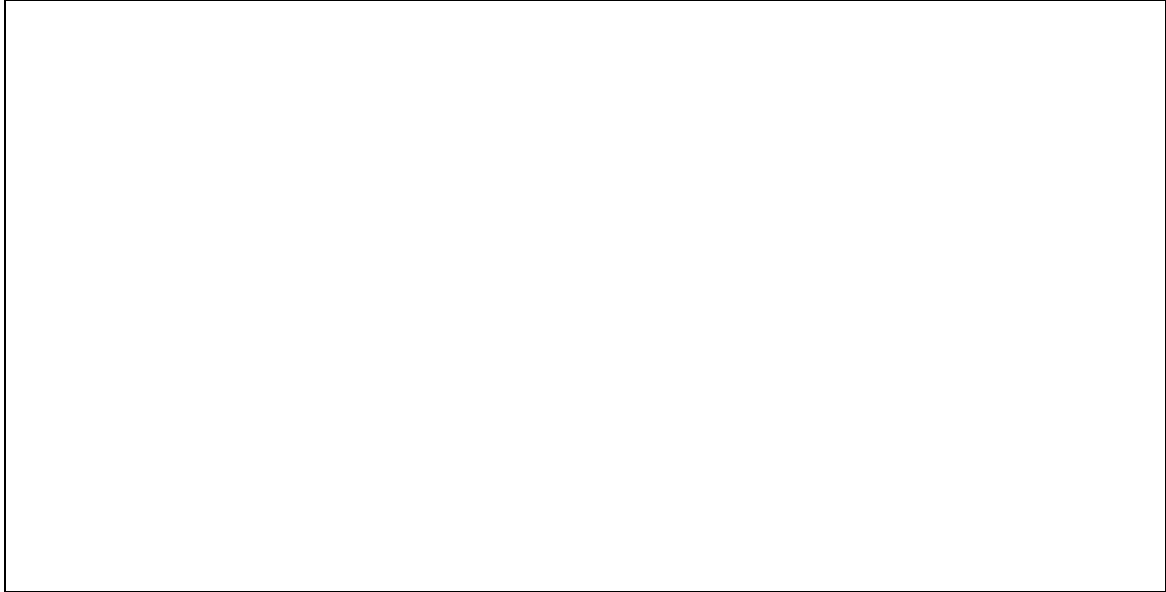

Any Visual Inspected Defects:



**Site Walk Through Checklist**

Potable Water / Flushing Water Pump Room

Equipment No. (Year Installed)	Location	Type (e.g. Potable / Flushing)	Flow Rate (L/s)	Rated Power (kW)	Brand	Model No.	Type of Drive (e.g. CSD/VSD)

Site Photo Record for Equipment

Any Visual Inspected Defects:

**Site Walk Through Checklist**

Lift Machine Room / Escalator Room

Equipment No. (Year Installed)	Location	Load Cap (kg)	Rated Power (kW)	Brand	Model No.	Type of Drive (e.g.VVVF/DC)	Idling Function (Y/N)	Speed Reducing Device (Y/N)

Site Photo Record for Equipment

Any Visual Inspected Defects:

Remarks: Please amend the form to suit individual case

Retro-Commissioning Plan

at

[Building Name]

[Date]

Document No.:

[XXXXXXXXXX]

## TABLE OF CONTENTS

- 1. Introduction**
  - 1.1 Executive Summary
  - 1.2 General Description of the Building
  - 1.3 Objectives of RCx
  - 1.4 Scope of Work in Planning Phase
  - 1.5 Members of the RCX Team
  - 1.6 Master Programme of RCx
  
- 2. Overview of 4 Energy Consumption Systems**
  - 2.1 Annual Energy Consumption
  - 2.2 HVAC System
  - 2.3 Electrical System
  - 2.4 Lighting System
  - 2.5 Lift and Escalator System
  
- 3. Current Facilities Requirements**
  
- 4. Preliminary Analysis**
  - 4.1 Existing Chiller Plant Efficiency
  - 4.2 Summary of Plant Cooling Load
    - 4.2.1 Daytime Peak Cooling Load in
    - 4.2.2 Overall Load Factor against Total Installed Capacity
    - 4.2.3 Average Load Factor of Each Chiller
  - 4.3 Occurrence Time of Cooling Load
  
- 5. Preliminary Analysis (Energy Modeling) [Optional]**
  - 5.1 Simulation Plan
  - 5.2 Input Parameter
  - 5.3 Simulation Findings
  
- 6. Data Verification and Site Measurement Plan**
  - 6.1 Data Verification
  - 6.2 Data Collection
  - 6.3 Site Measurement Plan

## 1. Introduction

### 1.1 Executive Summary

This paragraph should include but not limited to the followings:

- Summarize the preliminary findings in this stage
- Propose potential energy saving areas
- Propose the time frame and resources for the next stage

### 1.2 General Description of the Building

This paragraph should include but not limited to the followings:

- Building Location
- Year of Completion
- No. of Storey
- Total Cooling Capacity
- Brief description of the Central Chiller Plant

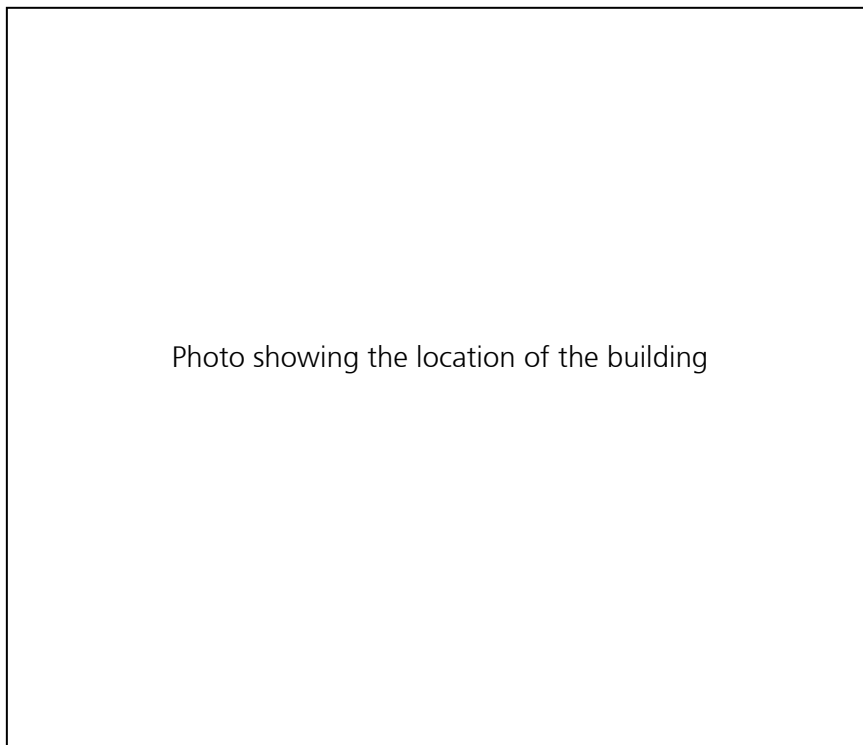

*Figure 1.1a: [Location of Building]*

### 1.3 Objectives of RCx

This paragraph should include but not limited to the followings:

- Brief description of RCx
- Purpose that wants to achieve

### 1.4 Scope of Work in Planning Phase

This paragraph should include but not limited to the followings:

- Commencement Date of the Project
- Scope of work in planning phase

### 1.5 RCx Team

Members participated in the Retro-Commissioning are as below;

Members	Name	Contact No.	Company
Building Owner			
Building Manager			
O&M Staff			
Service Provider			

*Table 1.4a: Table of RCx Team Members*

1.6 Master Programme of RCx

A master programme of RCx should be attached here.



## 2. Overview of 4 Energy Consumption Systems

### 2.1 Annual Energy Performance

This paragraph should include but not limited to the followings:

- Description of current annual energy performance (by electricity bill)
- Description of current annual energy performance (by simulation ) [Optional]
- Description of the breakdown of total energy consumption

	Air Conditioning Installation	Lighting and Small Power Installation	Lift Installation	Plumbing and Drainage Installation	Others	Total
Energy Consumption (MJ)						
Percentage						

*Table 2.1a: Breakdown of Total Energy Consumption in the past 12 months*

	Air Conditioning Installation	Lighting and Small Power Installation	Lift Installation	Plumbing and Drainage Installation	Others	Total
Energy Consumption (MJ)						
Percentage						

*Table 2.1b: Breakdown of Total Energy Consumption in the past 12 months (By Simulation) [Optional]*

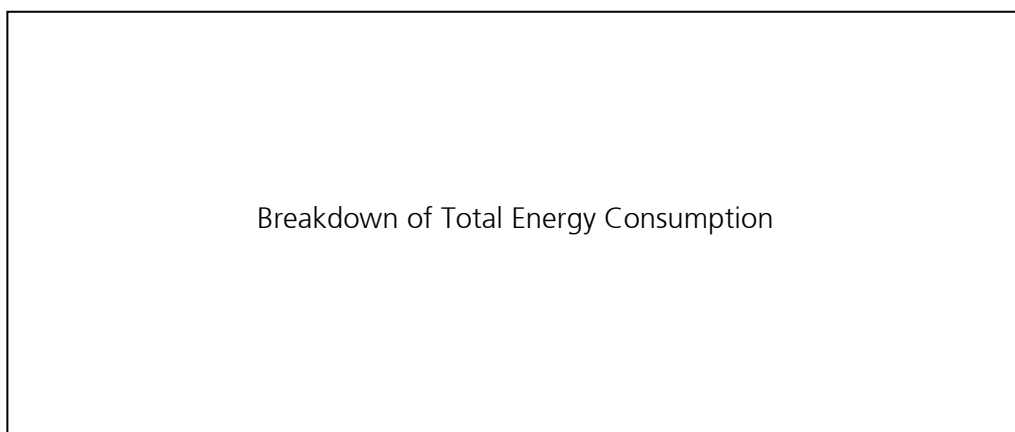

*Figure 2.1a: Breakdown of Total Energy Consumption*

## 2.2 HVAC System

### Central Chiller Plant

This section should include but not limited to the followings:

- Detailed description of the Central Chiller Plant (i.e No. of water-cooled/ air-cooled chiller/ heat pump / etc, Cooling capacity of respective chillers, Operation Time of the plant, Served Area, Central Chiller Plant Control System)
- Existing schematic piping diagram of the building
- Summary of existing chillers (Refer to Table 2.2a)
- Summary of existing chilled water pumps (Refer to Table 2.2b)
- Operating schedule of existing chillers (Refer to Table 2.2c)
- Detailed description of different operation mode
- Cooling capacity under different operation mode
- Area served under different operation mode

Equipment No.	Location	Installed Capacity (Ton)	Chilled Water Temp. (deg C) Supply Return	Flow Rate (L/s)	Evaporator Pressure (kPa)	Condenser Pressure (kPa)	Rated Power (kW)	Brand	Model No.	Type of Drive (e.g.CSD/VSD)

**Table 2.2a: Summary of existing chillers**

Equipment No.	Location	Flow Rate (L/s)	Rated Power (kW)	Brand	Model No.	Type of Drive (e.g.CSD/VSD)

**Table 2.2b: Summary of existing chilled water pumps**

Plant Location	Chiller No.	Operating Hour	Area Served

**Table 2.2c: Operating schedule of existing chillers**

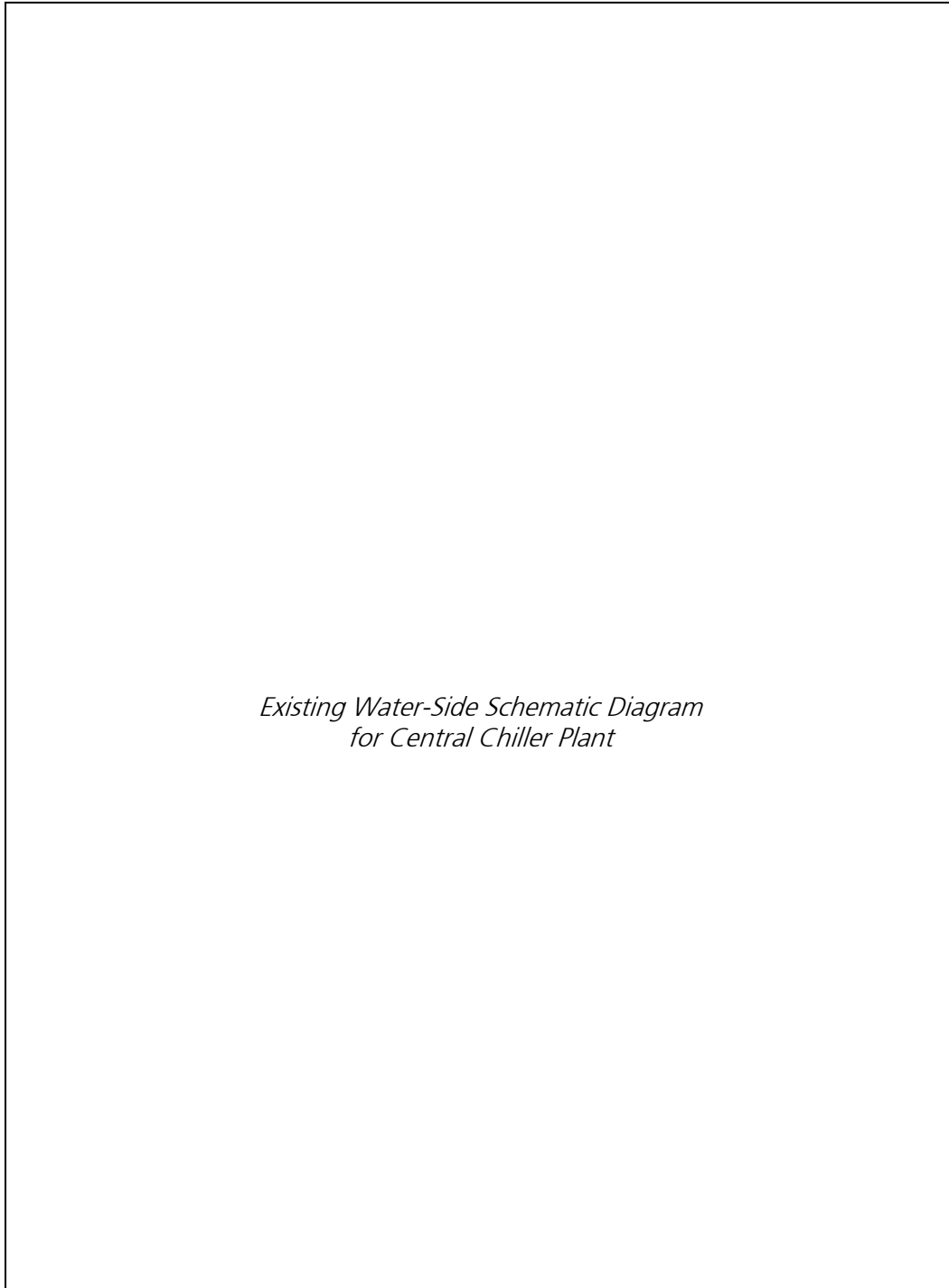

*Existing Water-Side Schematic Diagram  
for Central Chiller Plant*

*Figure 2.2a: Existing Water-Side Schematic Diagram for Central Chiller Plant*

## 2.3 Electrical System

### Electrical installation

This paragraph should include but not limited to the followings:

- Description of existing electrical system including the description of electrical schematic
- Identification of major items served by the transformers / generator
- Description of used capacitor bank
- Identification of capacitor bank location
- Description of used harmonic filter
- Identification of harmonic filter location

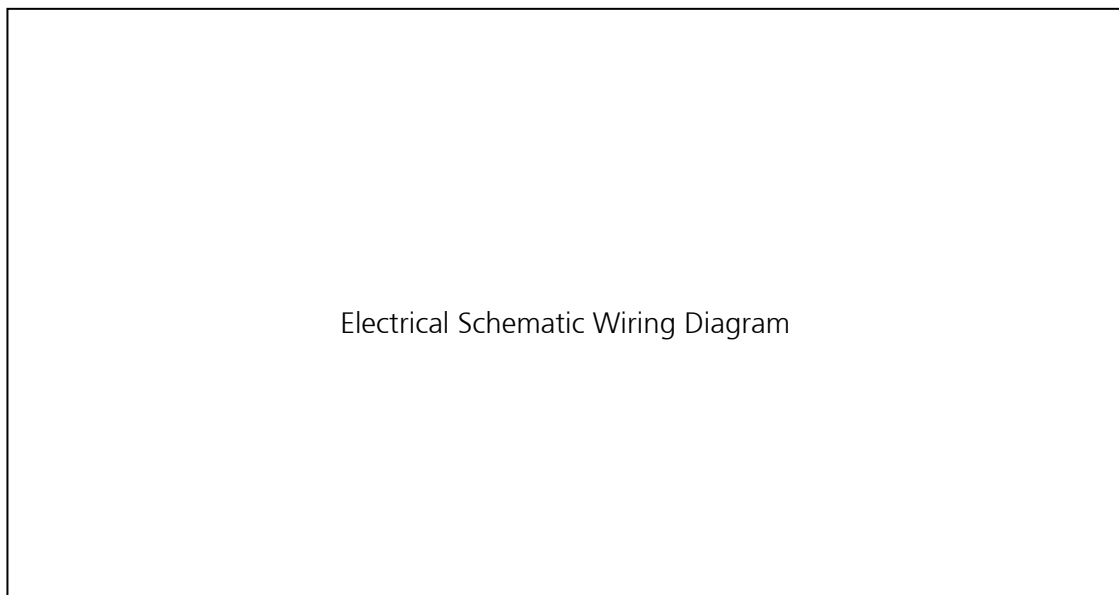

*Figure 2.3a: Electrical Schematic Wiring Diagram*

## 2.4 Lighting System

### 2.4.1 Lighting Installation

This paragraph should include but not limited to the followings:

- Description of existing lighting system including typical type of lamps
- Description of existing lighting control system
- Identification of any energy saving measures adopted such as motion and daylight sensor

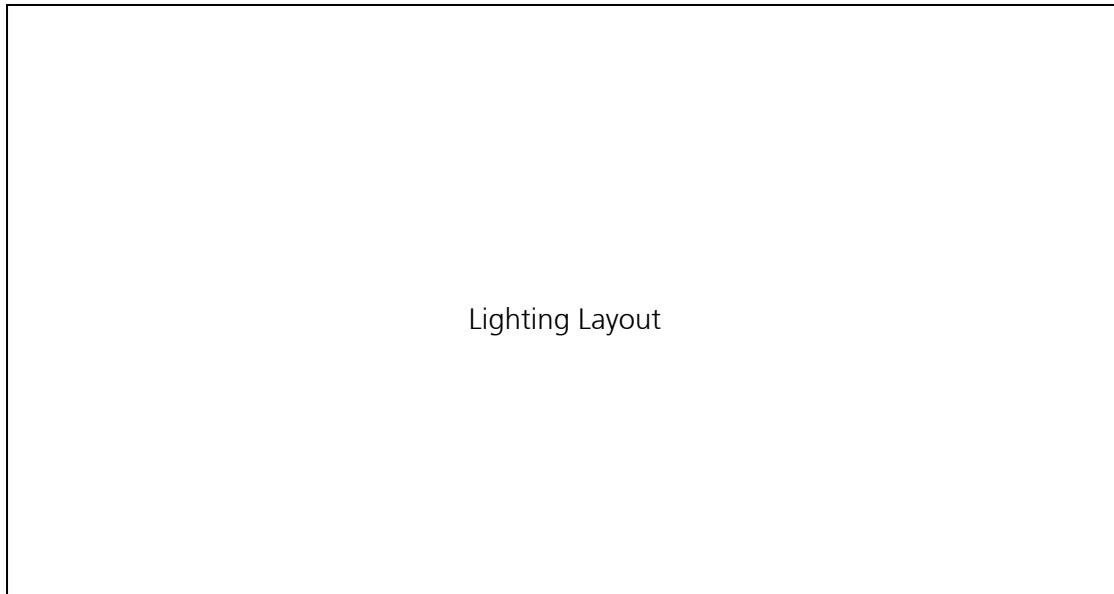

*Figure 2.4a: Lighting Layout*

Location	Type of Lighting	Quantity	Power (W)	Operation Hours

*Figure 2.4b: Lighting Schedule*

## 2.5 Lift and Escalator System

### Lift and Escalator Installation

This paragraph should include but not limited to the followings:

- Description of existing lift and escalator system including the number of lifts and escalator, type of drive and serving floors
- Identification of any energy saving measures adopted

#### Lift

Equipment No.	Brand	Load Cap (Kg)	Speed (m/s)	Serving Floors	Power (kW)	Operation Hours	Type of Drive (e.g. VSD/VVVF)	Idling Function (Y/N)	Speed Reducing Device (Y/N)

#### Escalator

Equipment No.	Brand	Load Cap (Kg)	Speed (m/s)	Serving Floors	Power (kW)	Operation Hours	Type of Drive (e.g. VSD/VVVF)	Idling Function (Y/N)	Speed Reducing Device (Y/N)

### 3. Current Facilities Requirements

This paragraph should include but not limited to the followings:

- Description of current user required information under Air Conditioning Provision and Mechanical Ventilation Provision (Temperature, Humidity, Exhaust Rate)
- Description of current user required information under Lighting Provision(Lux Level) and MV Provision
- Description of area operating schedule for occupancy

For details, please refer to Form 1.2 – Current Facilities Requirements Form.

#### 4. Preliminary Analysis and Findings

##### 4.1 Existing Chiller Efficiency Analysis

This paragraph should include but not limited to the followings:

- Description of building cooling load profile
- Description of energy consumption
- Description of existing chillers' performance and its COP values

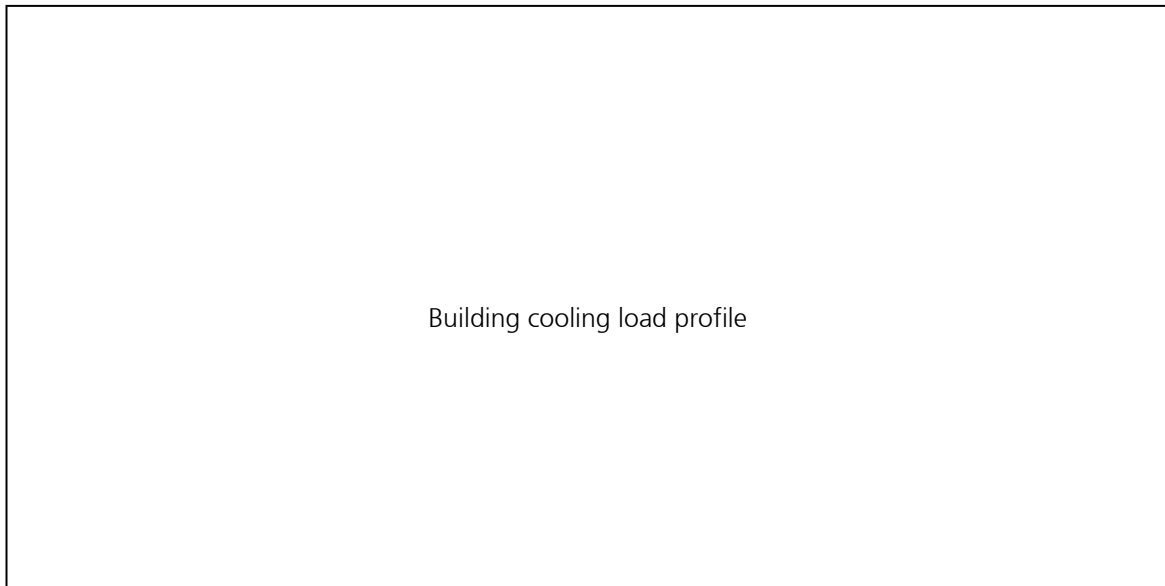

*Figure 4.1a: Building cooling load profile*

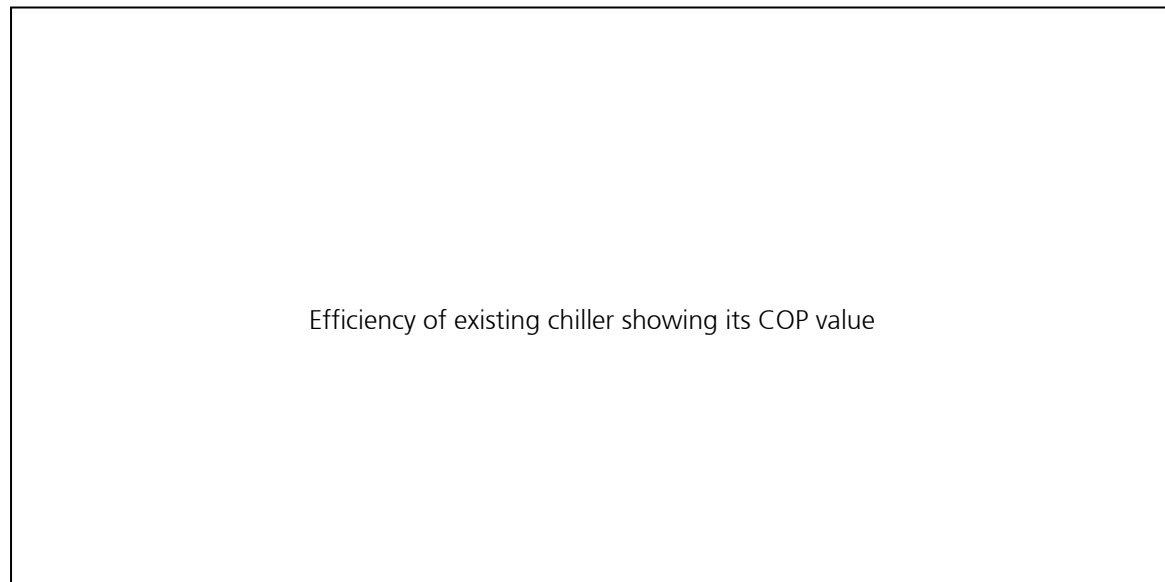

*Figure 4.1b: Efficiency of existing chiller plant*



## 4.2 Summary of Plant Cooling Load

### 4.2.1 Daytime Peak Cooling Load

This paragraph should include but not limited to the followings:

- Cooling load profile of the central chiller plant
- Peak cooling load throughout the year
- Summary of summer and winter cooling load

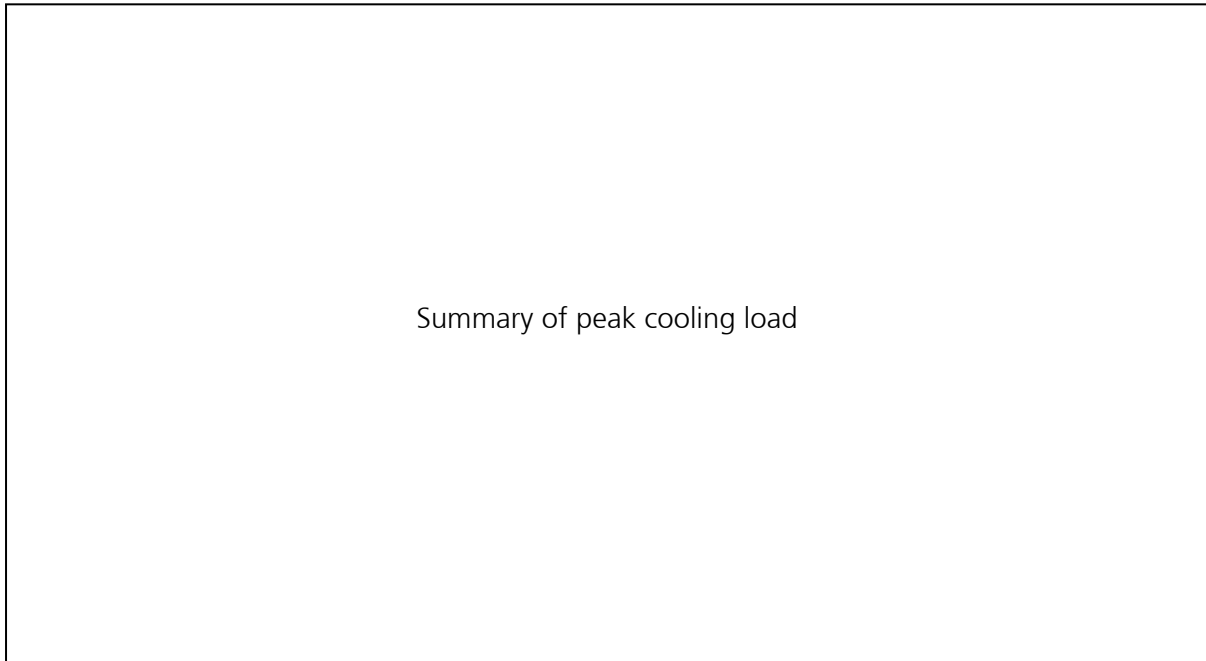
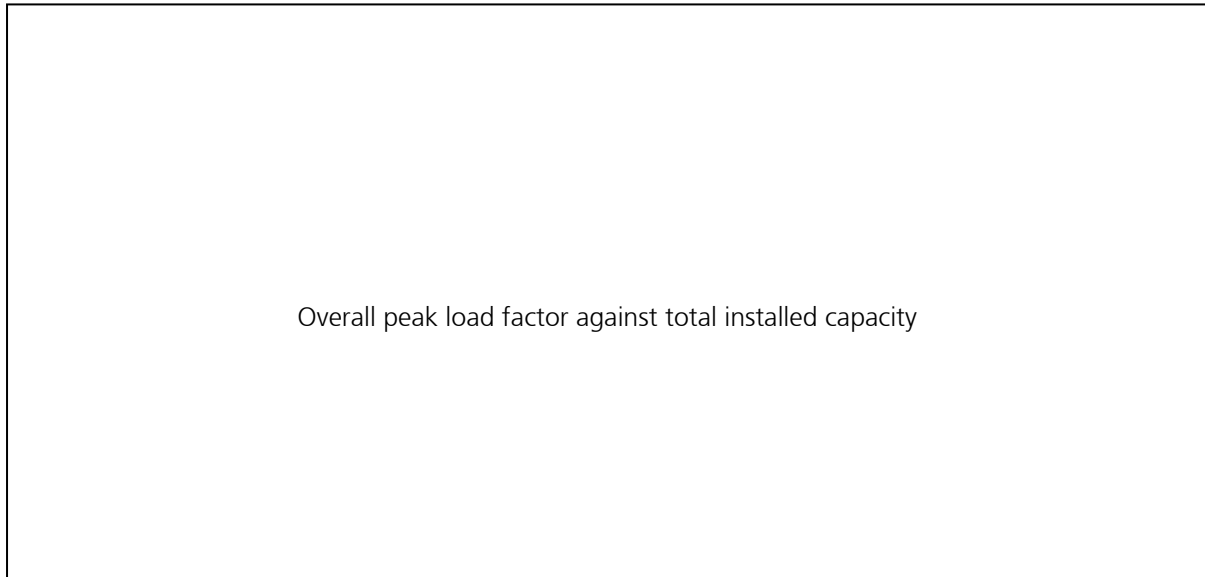

*Figure 4.2.1a: Summary of peak cooling loading*

#### 4.2.2 Overall Load Factor against Total Installed Capacity

This paragraph should include but not limited to the followings:

- Load factor of the central chiller plant throughout the year
- Load factor of the central chiller plant for each chiller
- Analysis of chiller sequencing



*Figure 4.1.2a: Overall peak load factor against total installed capacity*

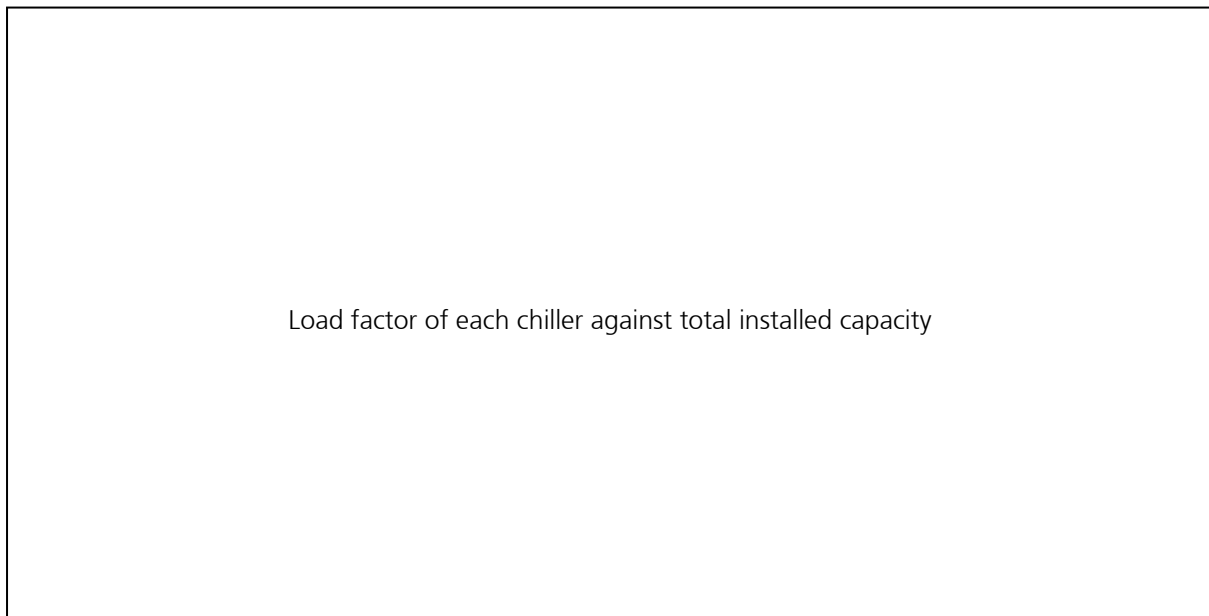

*Figure 4.1.2b: Load factor of each chiller against total installed capacity*

Plant Location	Peak Cooling Load (kW)	Total Installed Cooling Capacity (kW)	Load Factor
Breakdown	Cooling Capacity (kW)	Load Factor of its Installed Capacity	
Chiller A			
Chiller B			
Chiller C			
Chiller D			

*Table 4.1.2c: Peak load factor of chillers*

### 4.2.3 Average Load Factor of Each Chiller

This paragraph should include but not limited to the followings:

- Description and analysis of load factor of each chiller throughout the year

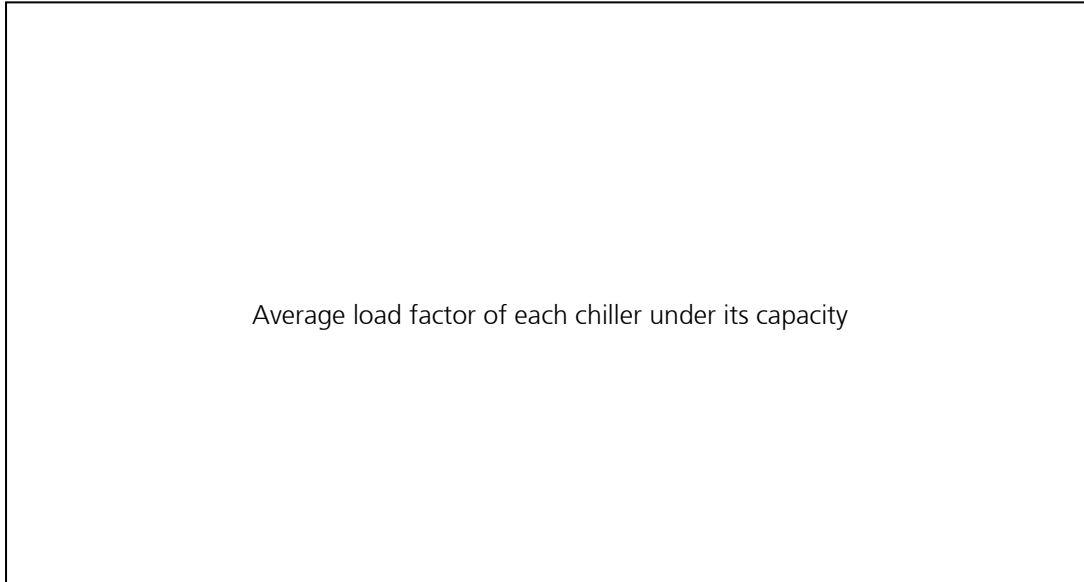

*Figure 4.2.3a: Average Load factor of each chiller under its capacity*

Plant Location	Chiller	Average Load Factor (Summer Period : Jun - Sept)

*Figure 4.2.3b: Average Load factor of each chiller during summer period*

### 4.3 Occurrence Time of Cooling Load

4.3.1 This paragraph should include but not limited to the followings:

- Description and analysis of cooling load occurrence time

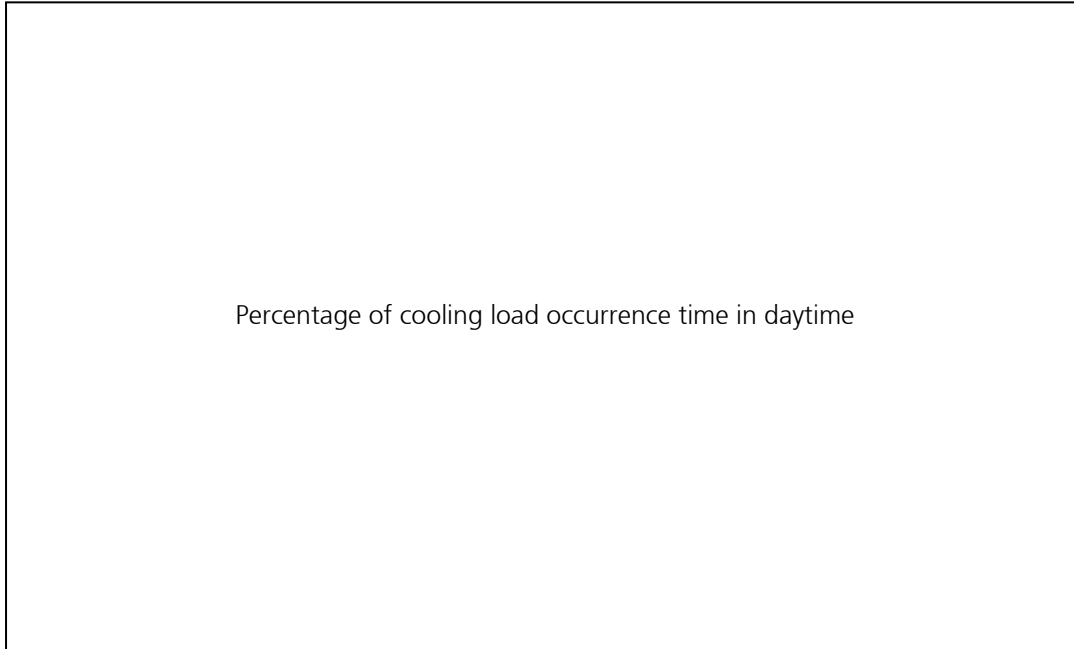

*Figure 4.3.1a: Percentage of cooling load occurrence time in daytime*

## 5. Preliminary Analysis and Findings (Energy Modelling)

### 5.1 Simulation Plan

This paragraph should include but not limited to the followings:

- Description of the whole simulation plan in 6 phases:
  - Step 1: Information Collection
  - Step 2: Calibration on energy model (First stage analysis)
  - Step 3: Calibration on the utilities bills
  - Step 4: Simulate the recent performance of building (Second stage analysis)
  - Step 5: Gap detection
  - Step 6: On-going Retro-Commissioning

### 5.2 Input Parameters

- Sample of input

Model Input Component	
<b>Building Envelop</b>	
1	Exterior wall U-value (W/m <sup>2</sup> .K)
2	Roof U-value (W/m <sup>2</sup> .K)
3	Fenestration U-value(W/m <sup>2</sup> .K)
4	Fenestration SC
5	Windows to wall ratio (overall)( %)
<b>Internal Load</b>	
6	Occupancy Density (m <sup>2</sup> /pax)
7	Lighting Power Density (W/m <sup>2</sup> )
8	Office Receptacle equipment (W/m <sup>2</sup> )
<b>HVAC System</b>	
8	Chiller Plant System
9	Chilled Water Distribution System
10	Indoor Design Temperature (deg C)
11	Chiller Capacity (kW)
12	Chiller COP
13	Pump & Fan Flow Rate and Power
14	Split unit COP

### 5.3 Simulation Findings

This paragraph should include but not limited to the followings:

- Description of the simulation findings, including the ambient temperature comparison between the energy audit report and simulation model (if there is no energy audit report, annual energy consumption should be used by logged data)
- Description of annual Energy Performance Comparison between energy audit report and simulation model (if there is no energy audit report, annual energy consumption should be used by logged data)

(kWh)	Air Conditioning Installation	Lighting and Small Power Installation	Lift Installation	Plumbing and Drainage Installation	Others	Total
Simulation						
Energy Audit Report						
Deviations						

Figure 5.3c: Annual Energy Performance Comparison between Simulation and Audit Report

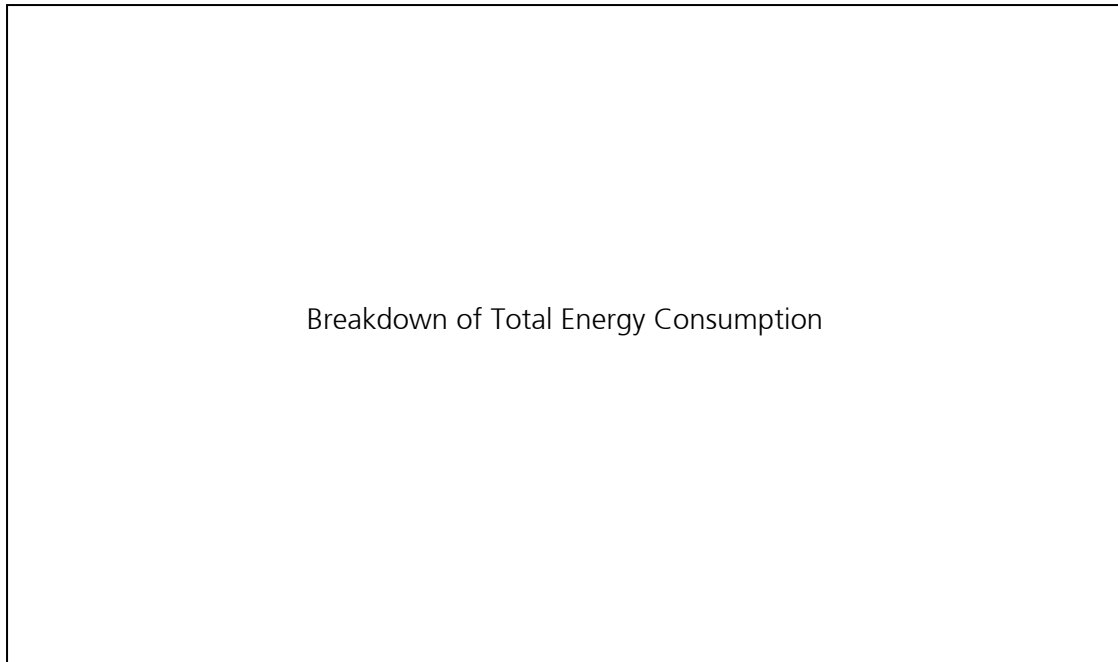

Figure 5.3d: Breakdown of Total Energy Consumption

## 6. Data Verification and Site Measurement Plan

### 6.1 Data Verification

Data Verification aims at verify the sensor accuracy and to check if the measured data deviates much with the readings. If this situation happens, a correction factor needs to be made on the log sheet data and its analysis.

This paragraph should include but not limited to the followings:

- Clarify the necessity of verifying the data
- List out the necessary verified data in the site measurement plan which should be attached in this section

### 6.2 Data Collection

Data Collection aims at collecting the missing items that BMS or O&M staff did not record. Those data is needed for further analysis to see if there is any abnormality or improvement on the system.

This paragraph should include but not limited to the followings:

- Clarify the necessity of collecting data
- List out the necessary data to be collected in the site measurement plan which should be attached in this section

### 6.3 Site Measurement Plan

Site Measurement Plan aims at gathering a list of items that needs to be verified and collected. Some items can be developed from preliminary analysis and collected materials.

A site measurement plan should consider following aspects:

- Water Cooled Chiller and Chilled Water Circuit
- Heat Rejection System
- Day Mode Circuit
- Night Mode Circuit
- Air Side Circuit
- Electrical System
- Lighting System
- Lift and Escalator System

A sample site measurement plan is provided on next page.





**Form 2.1 – Instrumentation for Data Collection using Portable Data Logger**

(A)	HVAC Measurement Instruments	Measured Parameter / Remarks
	Voltmeter	Voltage
	Ammeter	Current
	Wattmeter	Active Power (kW)
	Power factor meter	Power Factor / Apparent power (kVA) calculation
	Power quality analyzer	Harmonic contents / Other electrical parameters
	Pitotstatic tube manometer	Air flow pressure and velocity
	Digital type anemometer with probe	Air flow velocity and pressure
	Vane type anemometer	Air velocity through a coil, air intake, or discharge, for flows that are not dynamically unstable, typical flow velocity 0.25m/s to 15m/s
	Hood type anemometer	Flow rate of air grille
	Pressure gauge	Liquid pressure
	Ultrasonic flow meter with pipe clamps	Liquid flow/velocity
	Thermometer	Dry bulb temperature in oC
	Sling Psychrometer (thermometer)	Both dry and wet bulb temperature in °C
	Portable electronic thermometer	
	Infrared remote temperature sensing gun	Useful to sense energy losses due to improper insulation or leakage
	Digital thermometer with temperature probe	Temperature inside a stream of normally hot air/steam (platinum probe for temperature from 0 to 100 °C, and thermocouple probe for high temperatures as much as 1200 °C)
	CO2 Sensor	Concentration of carbon dioxide (ppm)
(B)	Electrical Measurement Instruments	Measured Parameter / Remarks
	Voltmeter	Voltage
	Ammeter	Current
	Wattmeter	Active Power (kW)
	Power factor meter	Power Factor / Apparent power (kVA) calculation
	Power quality analyzer	Harmonic contents / Other electrical parameters

Technical Guidelines on Retro-Commissioning

(C)	Lighting Measurement Instruments	Measured Parameter / Remarks
	Light meter (lux meter)	Lighting level in lux (illuminance / illumination level)
(D)	Lift and Escalator Measurement Instruments	Measured Parameter / Remarks
	Voltmeter	Voltage
	Ammeter	Current
	Wattmeter	Active Power (kW)
	Power factor meter	Power Factor / Apparent power (kVA) calculation
	Power quality analyzer	Harmonic contents / Other electrical parameters



**Form 2.2b – Chilled Water Plant – Chilled Water Pump Data Collection Form**

Chilled Water Plant --- Chilled Water Pump Specification      Chilled Water Pump Data Collected by BMS Logged Data / On-site Measurement

Designation	Date: _____ Ambient Air Temperature (°C): Mean: _____ Max: _____ Min: _____ Relative Humidity: _____												
Location	Time Interval	Chilled Water Pump 01			Chilled Water Pump 02			Chilled Water Pump 03			Overall Chilled Water Pump		
Model No.		Flow rate (L/s)	Running Current (Amp)	Power Input (kW)	Flow rate (L/s)	Running Current (Amp)	Power Input (kW)	Flow rate (L/s)	Running Current (Amp)	Power Input (kW)	Flow rate (L/s)	Running Current (Amp)	Power Input (kW)

Remarks: Please amend the form to suit individual case

Form 2.2c – Heat Rejection Plant – Cooling Tower Data Collection Form

Heat Rejection Plant Specification

Designation	
Location	
Model No.	

Heat Rejection Plant Data Collected by BMS Logged Data / On-site Measurement

Date: _____					Ambient Air Temperature (°C): Mean: _____ Max: _____ Min: _____				Relative Humidity: _____	
Time Interval	Cooling Tower Electrical Data				Condensing Water					
	Fan Input Power (kW)	Heat Rejection Equipment Consumed Power (kW)	Temperature (°C)		Flow Rate (L/s)					
			Supply	Return						

Remarks: Please amend the form to suit individual case

Form 2.2d – Heat Rejection Plant – Condensing Water Pump Data Collection Form

Heat Rejection Plant --- Condensing Water Pump Specification    Condensing Water Pump Data Collected by BMS Logged Data / On-site Measurement

Designation	Date:					Ambient Air Temperature (°C): Mean:    Max:    Min:			Relative Humidity:				
	Time Interval	Condensing Water Pump 01			Condensing Water Pump 02			Condensing Water Pump 03			Overall Condensing Water Pump		
		Flow rate (L/s)	Running Current (Amp)	Power Input (kW)	Flow rate (L/s)	Running Current (Amp)	Power Input (kW)	Flow rate (L/s)	Running Current (Amp)	Power Input (kW)	Flow rate (L/s)	Running Current (Amp)	Power Input (kW)
Location													
Model No.													

Remarks: Please amend the form to suit individual case

Form 2.2e – Central Hot Water Plant Data Collection Form

Central Hot Water Plant Specification

Designation	
Location	
Model No.	

Central Hot Water Plant Data Collected by BMS Logged Data / On-site Measurement

Date:		Ambient Air Temperature (°C): Mean: Max: Min:			Relative Humidity:		
Time Interval	Central Hot Water Plant Electrical Data				Hot Water		
	CoP	Steam Supply Pressure (kPa)	Boiler Input Power (kW)	Boiler Consumed Power (kW)	Temperature (°C)		Flow Rate (L/s)
Supply					Return		

Remarks: Please amend the form to suit individual case



Form 2.2f – Central Hot Water Plant – Hot Water Pump Data Collection Form

Central Hot Water Plant --- Hot Water Pump Specification      Hot Water Pump Data Collected by BMS Logged Data / On-site Measurement

Designation	Date:		Ambient Air Temperature (°C): Mean:    Max:    Min:			Relative Humidity:							
	Location	Hot Water Pump 01			Hot Water Pump 02			Hot Water Pump 03			Overall Hot Water Pump		
		Flow rate (L/s)	Running Current (Amp)	Power Input (kW)	Flow rate (L/s)	Running Current (Amp)	Power Input (kW)	Flow rate (L/s)	Running Current (Amp)	Power Input (kW)	Flow rate (L/s)	Running Current (Amp)	Power Input (kW)
Model No.													

Remarks: Please amend the form to suit individual case

Form 2.2g – Air Side System – AHU / PAU / FCU / Indoor Unit Data Collection Form

Air Side System (AHU / PAU/ FCU/ Indoor Unit) Specification

Air Side Data (AHU / PAU /FCU/ Indoor Unit) Collected by BMS Logged Data / On-site Measurement

Designation		Date:								Ambient Air Temperature (°C): Mean:		Max:		Min:		Relative Humidity:	
Location		Time Interval	AHU / PAU / FCU /Indoor unit										Fan Running Current (A)	Fan Running Power (kW)			
Model No.			Chilled Water		Air												
Description	<u>Design Value:</u> Chilled Water Supply Temperature: Supply Air Temperature:		Temperature (°C)		Temperature (°C)		Flow rate (L/s)										
		Supply	Return	Supply	Return	Supply	Return										

Remarks: Please amend the form to suit individual case

**Form 2.3 – List of Proposed Energy Saving Opportunities (ESOs)**

System Tuning Works

Item	Description of ESO (including intend results and energy baselines)	Estimated Annual Energy Saving (kWh)	Proposed Work Agent	Additional Cost if required (HK\$)	Implementation Duration	Payback Period	Measurement and Verification Methodology (*)	Disturbance to Existing System	Implementation
									<input type="checkbox"/> Yes <input type="checkbox"/> No
									<input type="checkbox"/> Yes <input type="checkbox"/> No
									<input type="checkbox"/> Yes <input type="checkbox"/> No
									<input type="checkbox"/> Yes <input type="checkbox"/> No

Upgrading Works

Item	Description of ESO (including intend results and energy baselines)	Estimated Annual Energy Saving (kWh)	Proposed Work Agent	Additional Cost if required (HK\$)	Implementation Duration	Payback Period	Measurement and Verification Methodology (*)	Disturbance to Existing System	Implementation
									<input type="checkbox"/> Yes <input type="checkbox"/> No
									<input type="checkbox"/> Yes <input type="checkbox"/> No
									<input type="checkbox"/> Yes <input type="checkbox"/> No
									<input type="checkbox"/> Yes <input type="checkbox"/> No

Overall Annual Energy Saving (kWh):

Remarks: (a) By Comparing the Electricity Bills

(b) By Measurement

(c): By Energy Modeling Simulation

(d): Others

Remarks: Please amend the form to suit individual case

**Form 2.4 – List of Proposed Repairing Items**

Repairing Works

---

Item	Description of Repairing Items	Justification on its effect in conducting RCx	Proposed Work Agent	Additional Cost if required (HK\$)	Implementation Duration

Remarks: Please amend the form to suit individual case

Investigation Report

at

[Building Name]

[Date]

Document No.:

[XXXXXXXXXX]

## TABLE OF CONTENTS

<b>1.</b>	<b>Introduction</b>
1.1	Executive Summary
1.2	General Description of the Building
<b>2.</b>	<b>Central Building Services Installation System Configurations</b>
2.1	HVAC System
2.2	Electrical System
2.3	Lighting System
2.4	Lift and Escalator System
<b>3.</b>	<b>Summary of Building Information Collected</b>
3.1	Summary Table of Collected Items
<b>4.</b>	<b>Findings on Walk Through Survey with Maintenance Team</b>
4.1	Description of work done in phase 1 (Planning Phase)
4.2	Walk-Through Photos
4.3	Contact List of Relevant Parties
<b>5.</b>	<b>Difficulties Encountered During Investigation and Improvement Recommendation</b>
5.1	Difficulties Encountered During Investigation Stage
5.2	Improvement Recommendation
<b>6.</b>	<b>Details of Site Measurement and Findings</b>
6.1	Verified Data
6.2	Collected Data
6.3	Site Measurement Plan
6.4	Key Findings and Optimization Approach
<b>7.</b>	<b>Detailed Calculation of Proposed Energy Saving Opportunities</b>
7.1	ESO 1 XXXXXXXXXXXX
7.2	ESO 2 XXXXXXXXXXXX
7.3	ESO 3 XXXXXXXXXXXX
7.4	Summary Table of Overall Energy Savings
<b>8.</b>	<b>Measurement and Verification (M&amp;V Plan)</b>
	<b>Appendix 1 – Building Current Operating Checklist</b>
	<b>Appendix 2 – Site Measurement Plan</b>
	<b>Appendix 3 – Method Statement of Site Measurement Plan</b>
	<b>Appendix 4 – Proposed Repairing Items</b>
	<b>Appendix 5 – Proposed Energy Saving Opportunities</b>

Implementation Report

at

[Building Name]

[Date]

Document No.:

[XXXXXXXXXX]

## TABLE OF CONTENTS

<b>1.</b>	<b>Introduction</b>
1.1	Executive Summary
1.2	Owner's Operating Requirements
<b>2.</b>	<b>Methodology of Each ESO</b>
2.1	Methodology of ESO 1 XXXXXXXXXXXX
2.2	Methodology of ESO 2 XXXXXXXXXXXX
2.3	Methodology of ESO 3 XXXXXXXXXXXX
<b>3.</b>	<b>Measurement and Verification</b>
3.1	ESO 1 Data Analysis and Verification
3.2	ESO 2 Data Analysis and Verification
3.3	ESO 3 Data Analysis and Verification
<b>4.</b>	<b>Conclusion</b>
4.1	Summary Table of ESOs Actual Savings
4.2	A list of Capital Improvements Recommended for Further Investigation



On-going Commissioning Report

at

[Building Name]

[Date]

Document No.:

[XXXXXXXXXX]

## TABLE OF CONTENTS

- 1. Introduction**
  - 1.1 Executive Summary
  
- 2. Documentation Policies and Procedures**
  - 2.1 HVAC System
  - 2.2 Electrical System
  - 2.3 Lighting System
  - 2.4 Lift and Escalator System
  
- 3. Usage of Key Performance Indicator**
  
- 4. Recommended Training for O&M Staff**